



Republic of the Philippines
ROAD BOARD
OFFICE OF THE CHAIRMAN
 2/4F Ave Maria Building, 1517 Quezon Avenue corner Examiner Street
 West Triangle, Quezon City

INVITATION TO BID
SUPPLY AND DELIVERY OF ROAD SIGNAGES
ALONG NATIONAL ROADS NATIONWIDE
(PACKAGE 1B-WARNING SIGNS)

1. The **Road Board (RB)**, through the **MVUC Special Road Safety Fund (Fund-153)** for **CY-2014** intends to apply the sum of **One Hundred Twenty Million Nine Hundred Forty-Nine Thousand One Hundred Ninety-Seven Pesos and 24/100 (Php120,949,197.24)** being the Approved Budget for the Contract (ABC) to payments under the contract for **Supply and Delivery of Road Signages along National Roads Nationwide (Package 1B-Warning Signs)**. Bids received in excess of the ABC shall be automatically rejected at bid opening.
2. The **Road Board** now invites bids for **Supply and Delivery of Road Signages along National Roads Nationwide (Package 1B-Warning Signs)**.

DELIVERY SITE DPWH Regional Office	TYPE AND QUANTITY									TOTAL
	Curve Sign (WI-3)		Winding Road Sign	Cross Road Sign	Priority Road Sign			Narrow Bridge Sign	Divided Road Sign	
	Right	Left	WI-5	W2-1	W2-8	W2-9	W2-9	W4-1P	W4-3	
NCR	27	27	6	67	114	53	157	6	12	469
CAR	242	242	202	12	50	14	16	10	6	794
RI	134	134	104	34	90	4	4	28	4	536
RII	169	169	90	26	80	20	16	18	2	590
RIII	129	129	86	88	166	38	44	68	12	760
RIV-A	182	182	84	38	44	20	22	38	35	645
RIV-B	158	158	88	18	70	18	20	62	10	602
RV	321	321	280	136	188	26	26	10		1,308
RVI	266	266	210	46	112	278	24	42	36	1,280
RVII	166	166	146	138	208	16	12	84	20	956
RVIII	255	255	132	28	144	16	34	12	20	896
RIX	275	275	130	72	152	22	16	26	30	998
RX	321	321	176	36	174	20	28	15	24	1,115
RXI	286	286	108	44	126	18	20	26	12	926
RXII	92	92	90	82	228	10	14	14	21	643
RXIII	185	185	100	39	194	2	2	14	16	737
TOTAL	3,208	3,208	2,032	904	2,140	575	455	473	260	13,255

Delivery of Goods is required **within 260 calendar days from the first day of contract as stated in the Notice to Proceed**. Bidders should have completed **prior to the deadline for the submission and receipt of bids a single contract that is similar to the contract to be bid, whose value, adjusted to current prices using the National Statistics Office (NSO) consumer price indices, must be at least fifty percent (50%) of the ABC. For this purpose, similar contract shall refer to supply and delivery of all kinds of road safety signages, not to include guardrails, thermoplastic pavement markings and other road safety devices**. The description of an eligible bidder is contained in the Bidding Documents, particularly, in Section II. Instructions to Bidders.

3. Bidding will be conducted through open competitive bidding procedures using a non-discretionary "pass/fail" criterion as specified in the Implementing Rules and Regulations (IRR) of Republic Act (RA) 9184, otherwise known as the "Government Procurement Reform Act".

Bidding is restricted to Filipino citizens/sole proprietorships, partnerships, or organizations with at least sixty percent (60%) interest or outstanding capital stock belonging to citizens of the Philippines, and to citizens or organizations of a country the laws or regulations of which grant similar rights or privileges to Filipino citizens, pursuant to RA 5183 and subject to Commonwealth Act 138.

4. Interested bidders may obtain further information, inspect and purchase the complete set of Bidding Documents from the **RB BAC Secretariat Office, 2nd Floor Ave Maria Building, 1517 Quezon Avenue cor. Examiner St., Quezon City**, upon submission of a Letter of Intent and payment of a non-refundable fee of **Fifty Thousand Pesos (Php50,000.00)** from **October 29, 2014 up to 12:00:00 noon of November 24, 2014**.

It may also be downloaded free of charge from the website of the Philippine Government Electronic Procurement System (PhilGEPS) and from the Procuring Entity's website, provided that Bidders shall submit their Letter of Intent pay the non-refundable fee for the Bidding Documents not later than the submission of their bids.

5. The **Road Board** will hold a Pre-Bid Conference on **November 12, 2014 (Wednesday) 10:00 AM** at the **RBS Conference Room, 4th Floor Ave Maria Building, 1517 Quezon Avenue cor. Examiner St., Quezon City**. The conference shall be open only to all interested parties who have purchased the Bidding Documents. **Interested parties who have not purchased the bidding documents will be allowed to attend as observers only.**
6. Bids must be delivered to the RB BAC Secretariat Office on or before **November 24, 2014 (Monday) 12:00:00 noon (PST)**. All Bids must be accompanied by a bid security in any of the acceptable forms and in the amount stated in **ITB** Clause 18.

Bids will be opened on **November 24, 2014 (Monday) 1:00 PM** at the **RBS Conference Room** in the presence of the bidders' representatives. Late bids shall not be accepted.

7. The Road Board reserves the right to accept or reject any bid, to annul the bidding process, and to reject all bids at any time prior to contract award, without thereby incurring any liability to the affected bidder or bidders.
8. For further information, please refer to:

Mr. Retchie O. Almeda
Office of the BAC Secretariat
2nd Floor Ave Maria Building

1517 Quezon Avenue cor. Examiner St.
Quezon City
Tel. No. (02) 376-62-69
Fax No. (02) 376-90-28

(Sgd.) ADOLFO L. ESCALONA
BAC Chairman
Road Board



Republic of the Philippines
ROAD BOARD
OFFICE OF THE CHAIRMAN

**SUPPLY AND DELIVERY OF ROAD SIGNAGES
ALONG NATIONAL ROADS NATIONWIDE
(PACKAGE 1B-WARNING SIGNS)**

**BIDDING DOCUMENT
COMPETITIVE PUBLIC BIDDING**

*Office of the ROAD BOARD Secretariat
2nd Floor Ave Maria Building, 1517 Quezon Avenue cor. Examiner St., Quezon City
Tel. No. 376-62-69 & Fax No. 376-90-28
<http://www.roadboard.gov.ph/>*

**NAME OF PROJECT: SUPPLY AND DELIVERY OF ROAD SIGNAGES
ALONG NATIONAL ROADS NATIONWIDE
(PACKAGE 1B-WARNING SIGNS)**

TABLE OF CONTENTS

SECTION I. INVITATION TO BID	6
SECTION II. INSTRUCTIONS TO BIDDERS.....	9
SECTION III. BID DATA SHEET.....	38
SECTION IV. GENERAL CONDITIONS OF CONTRACT	41
SECTION V. SPECIAL CONDITIONS OF CONTRACT	57
SECTION VI. SCHEDULE OF REQUIREMENTS.....	61
SECTION VII. TECHNICAL SPECIFICATIONS	63
SECTION VIII. BIDDING FORMS.....	71

Section I. Invitation to Bid



INVITATION TO BID

SUPPLY AND DELIVERY OF ROAD SIGNAGES ALONG NATIONAL ROADS NATIONWIDE (PACKAGE 1B-WARNING SIGNS)

9. The Road Board (RB), through the MVUC Special Road Safety Fund (Fund-153) for CY-2014 intends to apply the sum of **One Hundred Twenty Million Nine Hundred Forty-Nine Thousand One Hundred Ninety-Seven Pesos and 24/100 (Php120,949,197.24)** being the Approved Budget for the Contract (ABC) to payments under the contract for **Supply and Delivery of Road Signages along National Roads Nationwide (Package 1B-Warning Signs)**. Bids received in excess of the ABC shall be automatically rejected at bid opening.
10. The Road Board now invites bids for **Supply and Delivery of Road Signages along National Roads Nationwide (Package 1B-Warning Signs)**.

DELIVERY SITE DPWH Regional Office	TYPE AND QUANTITY									TOTAL
	Curve Sign (W1-3)		Winding Road Sign	Cross Road Sign	Priority Road Sign			Narrow Bridge Sign	Divided Road Sign	
	Right	Left	W1-5	W2-1	W2-8	W2-9	W2-9	W4-1P	W4-3	
NCR	27	27	6	67	114	53	157	6	12	469
CAR	242	242	202	12	50	14	16	10	6	794
RI	134	134	104	34	90	4	4	28	4	536
RII	169	169	90	26	80	20	16	18	2	590
RIII	129	129	86	88	166	38	44	68	12	760
RIV-A	182	182	84	38	44	20	22	38	35	645
RIV-B	158	158	88	18	70	18	20	62	10	602
RV	321	321	280	136	188	26	26	10		1,308
RVI	266	266	210	46	112	278	24	42	36	1,280
RVII	166	166	146	138	208	16	12	84	20	956
RVIII	255	255	132	28	144	16	34	12	20	896
RIX	275	275	130	72	152	22	16	26	30	998
RX	321	321	176	36	174	20	28	15	24	1,115
RXI	286	286	108	44	126	18	20	26	12	926
RXII	92	92	90	82	228	10	14	14	21	643
RXIII	185	185	100	39	194	2	2	14	16	737
TOTAL	3,208	3,208	2,032	904	2,140	575	455	473	260	13,255

Delivery of Goods is required **within 260 calendar days from the first day of contract as stated in the Notice to Proceed**. Bidders should have completed **prior to the deadline for the submission and receipt of bids a single contract that is similar to the contract to be bid, whose value, adjusted to current prices using the National Statistics Office (NSO) consumer price indices, must be at least fifty percent (50%) of the ABC**. For this purpose, *similar contract shall refer to supply and delivery of all kinds of road safety signages, not to include guardrails, thermoplastic pavement markings and other road safety devices*. The description of an eligible bidder is contained in the Bidding Documents, particularly, in Section II. Instructions to Bidders.

11. Bidding will be conducted through open competitive bidding procedures using a non-discretionary “pass/fail” criterion as specified in the Implementing Rules and Regulations (IRR) of Republic Act (RA) 9184, otherwise known as the “Government Procurement Reform Act”.

Bidding is restricted to Filipino citizens/sole proprietorships, partnerships, or organizations with at least sixty percent (60%) interest or outstanding capital stock belonging to citizens of the Philippines, and to citizens or organizations of a country the laws or regulations of which grant similar rights or privileges to Filipino citizens, pursuant to RA 5183 and subject to Commonwealth Act 138.

12. Interested bidders may obtain further information, inspect and purchase the complete set of Bidding Documents from the **RB BAC Secretariat Office, 2nd Floor Ave Maria Building, 1517 Quezon Avenue cor. Examiner St., Quezon City**, upon submission of a Letter of Intent and payment of a non-refundable fee of **Fifty Thousand Pesos (Php50,000.00)** from **October 29, 2014** up to **12:00:00 noon of November 24, 2014**.

It may also be downloaded free of charge from the website of the Philippine Government Electronic Procurement System (PhilGEPS) and from the Procuring Entity’s website, provided that Bidders shall submit their Letter of Intent pay the non-refundable fee for the Bidding Documents not later than the submission of their bids.

13. The **Road Board** will hold a Pre-Bid Conference on **November 12, 2014 (Wednesday) 10:00 AM** at the **RBS Conference Room, 4th Floor Ave Maria Building, 1517 Quezon Avenue cor. Examiner St., Quezon City**. The conference shall be open only to all interested parties who have purchased the Bidding Documents. **Interested parties who have not purchased the bidding documents will be allowed to attend as observers only.**

14. Bids must be delivered to the RB BAC Secretariat Office on or before **November 24, 2014 (Monday) 12:00:00 noon (PST)**. All Bids must be accompanied by a bid security in any of the acceptable forms and in the amount stated in **ITB** Clause 18.

Bids will be opened on **November 24, 2014 (Monday) 1:00 PM** at the **RBS Conference Room** in the presence of the bidders’ representatives. Late bids shall not be accepted.

15. The Road Board reserves the right to accept or reject any bid, to annul the bidding process, and to reject all bids at any time prior to contract award, without thereby incurring any liability to the affected bidder or bidders.

16. For further information, please refer to:

Mr. Retchie O. Almeda
Office of the BAC Secretariat
2nd Floor Ave Maria Building
1517 Quezon Avenue cor. Examiner St.
Quezon City
Tel. No. (02) 376-62-69
Fax No. (02) 376-90-28

(Sgd.) ADOLFO L. ESCALONA
BAC Chairman
Road Board

Section II. Instructions to Bidders

TABLE OF CONTENTS

A. GENERAL.....	11
1. Scope of Bid	11
2. Source of Funds.....	11
3. Corrupt, Fraudulent, Collusive, and Coercive Practices	11
4. Conflict of Interest.....	13
5. Eligible Bidders	14
6. Bidder’s Responsibilities	15
7. Origin of Goods	17
8. Subcontracts.....	17
B. CONTENTS OF BIDDING DOCUMENTS	17
9. Pre-Bid Conference.....	17
10. Clarification and Amendment of Bidding Documents.....	18
C. PREPARATION OF BIDS	18
11. Language of Bid.....	18
12. Documents Comprising the Bid: Eligibility and Technical Components	19
13. Documents Comprising the Bid: Financial Component.....	20
14. Alternative Bids.....	21
15. Bid Prices.....	21
16. Bid Currencies	23
17. Bid Validity.....	23
18. Bid Security.....	24
19. Format and Signing of Bids.....	26
20. Sealing and Marking of Bids.....	26
D. SUBMISSION AND OPENING OF BIDS	27
21. Deadline for Submission of Bids.....	27
22. Late Bids.....	27
23. Modification and Withdrawal of Bids.....	27
24. Opening and Preliminary Examination of Bids.....	28
E. EVALUATION AND COMPARISON OF BIDS.....	29

25.	Process to be Confidential.....	29
26.	Clarification of Bids	30
27.	Domestic Preference	30
28.	Detailed Evaluation and Comparison of Bids	31
29.	Post-Qualification.....	32
30.	Reservation Clause.....	33
F.	AWARD OF CONTRACT	34
31.	Contract Award	34
32.	Signing of the Contract	35
33.	Performance Security	36
34.	Notice to Proceed	37

General

1. Scope of Bid

- 1.1. The procuring entity named in the **BDS** (hereinafter referred to as the “Procuring Entity”) wishes to receive bids for supply and delivery of the goods as described in Section VII. Technical Specifications (hereinafter referred to as the “Goods”).
- 1.2. The name, identification, and number of lots specific to this bidding are provided in the **BDS**. The contracting strategy and basis of evaluation of lots is described in ITB Clause 28.

2. Source of Funds

The Procuring Entity has a budget or has applied for or received funds from the Funding Source named in the **BDS**, and in the amount indicated in the **BDS**. It intends to apply part of the funds received for the Project, as defined in the **BDS**, to cover eligible payments under the contract.

3. Corrupt, Fraudulent, Collusive, and Coercive Practices

- 3.1. Unless otherwise specified in the **BDS**, the Procuring Entity as well as the bidders and suppliers shall observe the highest standard of ethics during the procurement and execution of the contract. In pursuance of this policy, the Procuring Entity:
 - (a) defines, for purposes of this provision, the terms set forth below as follows:
 - (i) “corrupt practice” means behavior on the part of officials in the public or private sectors by which they improperly and unlawfully enrich themselves, others, or induce others to do so, by misusing the position in which they are placed, and includes the offering, giving, receiving, or soliciting of anything of value to influence the action of any such official in the procurement process or in contract execution; entering, on behalf of the government, into any contract or transaction manifestly and grossly disadvantageous to the same, whether or not the public officer profited or will profit thereby, and similar acts as provided in RA 3019.
 - (ii) “fraudulent practice” means a misrepresentation of facts in order to influence a procurement process or the execution of a contract to the detriment of the Procuring Entity, and includes collusive practices among Bidders (prior to or after bid submission) designed to establish bid prices at artificial, non-competitive levels and to deprive the

Procuring Entity of the benefits of free and open competition.

(iii) “collusive practices” means a scheme or arrangement between two or more Bidders, with or without the knowledge of the Procuring Entity, designed to establish bid prices at artificial, non-competitive levels.

(iv) “coercive practices” means harming or threatening to harm, directly or indirectly, persons, or their property to influence their participation in a procurement process, or affect the execution of a contract;

(v) “obstructive practice” is

(aa) deliberately destroying, falsifying, altering or concealing of evidence material to an administrative proceedings or investigation or making false statements to investigators in order to materially impede an administrative proceedings or investigation of the Procuring Entity or any foreign government/foreign or international financing institution into allegations of a corrupt, fraudulent, coercive or collusive practice; and/or threatening, harassing or intimidating any party to prevent it from disclosing its knowledge of matters relevant to the administrative proceedings or investigation or from pursuing such proceedings or investigation; or

(bb) acts intended to materially impede the exercise of the inspection and audit rights of the Procuring Entity or any foreign government/foreign or international financing institution herein.

(b) will reject a proposal for award if it determines that the Bidder recommended for award has engaged in any of the practices mentioned in this Clause for purposes of competing for the contract.

3.2. Further, the Procuring Entity will seek to impose the maximum civil, administrative, and/or criminal penalties available under applicable laws on individuals and organizations deemed to be involved in any of the practices mentioned in ITB Clause 3.1(a).

3.3. Furthermore, the Funding Source and the Procuring Entity reserve the right to inspect and audit records and accounts of a bidder or supplier in the bidding for and performance of a contract themselves or through independent auditors as reflected in the GCC Clause 3.

4. Conflict of Interest

4.1. All Bidders found to have conflicting interests shall be disqualified to participate in the procurement at hand, without prejudice to the imposition of appropriate administrative, civil, and criminal sanctions. A Bidder may be considered to have conflicting interests with another Bidder in any of the events described in paragraphs (a) through (c) below and a general conflict of interest in any of the circumstances set out in paragraphs (d) through (f) below:

- (a) A Bidder has controlling shareholders in common with another Bidder;
- (b) A Bidder receives or has received any direct or indirect subsidy from any other Bidder;
- (c) A Bidder has the same legal representative as that of another Bidder for purposes of this bid;
- (d) A Bidder has a relationship, directly or through third parties, that puts them in a position to have access to information about or influence on the bid of another Bidder or influence the decisions of the Procuring Entity regarding this bidding process. This will include a firm or an organization who lends, or temporarily seconds, its personnel to firms or organizations which are engaged in consulting services for the preparation related to procurement for or implementation of the project if the personnel would be involved in any capacity on the same project;
- (e) A Bidder submits more than one bid in this bidding process. However, this does not limit the participation of subcontractors in more than one bid; or
- (f) A Bidder who participated as a consultant in the preparation of the design or technical specifications of the Goods and related services that are the subject of the bid.

4.2. In accordance with Section 47 of the IRR of RA 9184, all Bidding Documents shall be accompanied by a sworn affidavit of the Bidder that it is not related to the Head of the Procuring Entity, members of the Bids and Awards Committee (BAC), members of the Technical Working Group (TWG), members of the BAC Secretariat, the head of the Project Management Office (PMO) or the end-user unit, and the project consultants, by consanguinity or affinity up to the third civil degree. On the part of the Bidder, this Clause shall apply to the following persons:

- (a) If the Bidder is an individual or a sole proprietorship, to the Bidder himself;
- (b) If the Bidder is a partnership, to all its officers and members;

- (c) If the Bidder is a corporation, to all its officers, directors, and controlling stockholders; and
- (d) If the Bidder is a joint venture (JV), the provisions of items (a), (b), or (c) of this Clause shall correspondingly apply to each of the members of the said JV, as may be appropriate.

Relationship of the nature described above or failure to comply with this Clause will result in the automatic disqualification of a Bidder.

5. Eligible Bidders

5.1. Unless otherwise provided in the **BDS**, the following persons shall be eligible to participate in this bidding:

- (a) Duly licensed Filipino citizens/sole proprietorships;
- (b) Partnerships duly organized under the laws of the Philippines and of which at least sixty percent (60%) of the interest belongs to citizens of the Philippines;
- (c) Corporations duly organized under the laws of the Philippines, and of which at least sixty percent (60%) of the outstanding capital stock belongs to citizens of the Philippines;
- (d) Cooperatives duly organized under the laws of the Philippines, and of which at least sixty percent (60%) of the interest belongs to citizens of the Philippines; and
- (e) Unless otherwise provided in the **BDS**, persons/entities forming themselves into a JV, *i.e.*, a group of two (2) or more persons/entities that intend to be jointly and severally responsible or liable for a particular contract: Provided, however, that Filipino ownership or interest of the joint venture concerned shall be at least sixty percent (60%).

5.2. Foreign bidders may be eligible to participate when any of the following circumstances exist, as specified in the **BDS**:

- (a) When a Treaty or International or Executive Agreement as provided in Section 4 of the RA 9184 and its IRR allow foreign bidders to participate;
- (b) Citizens, corporations, or associations of a country, included in the list issued by the GPPB, the laws or regulations of which grant reciprocal rights or privileges to citizens, corporations, or associations of the Philippines;
- (c) When the Goods sought to be procured are not available from local suppliers; or

- (d) When there is a need to prevent situations that defeat competition or restrain trade.
- 5.3. Government corporate entities may be eligible to participate only if they can establish that they (a) are legally and financially autonomous, (b) operate under commercial law, and (c) are not dependent agencies of the GOP or the Procuring Entity.
- 5.4. Unless otherwise provided in the **BDS**, the Bidder must have completed at least one contract similar to the Project the value of which, adjusted to current prices using the National Statistics Office consumer price index, must be at least equivalent to a percentage of the ABC stated in the **BDS**.

For this purpose, contracts similar to the Project shall be those described in the **BDS**, and completed within the relevant period stated in the Invitation to Bid and **ITB** Clause 12.1(a)(iii).

The Bidder must submit a computation of its Net Financial Contracting Capacity (NFCC) which must be at least equal to the ABC to be bid, calculated as follows:

NFCC = [(Current assets minus current liabilities) (K)] minus the value of all outstanding or uncompleted portions of the projects under ongoing contracts, including awarded contracts yet to be started coinciding with the contract for this Project.

Where:

K = 10 for a contract duration of one year or less, 15 for a contract duration of more than one year up to two years, and 20 for a contract duration of more than two years.

The values of the bidder's current assets and current liabilities shall be based on the data submitted to the BIR, through its Electronic Filing and Payment System (EFPS).

6. Bidder's Responsibilities

- 6.1. The Bidder or its duly authorized representative shall submit a sworn statement in the form prescribed in Section VIII. Bidding Forms as required in **ITB** Clause 12.1(b)(iii).
- 6.2. The Bidder is responsible for the following:
 - (a) the Bidding Documents;
 - (b) Having acknowledged all conditions, local or otherwise, affecting the implementation of the contract;
 - (c) Having made an estimate of the facilities available and needed for the contract to be bid, if any;

- (d) Having complied with its responsibility to inquire or secure Supplemental/Bid Bulletin(s) as provided under **ITB** Clause 10.3.
- (e) Ensuring that it is not “blacklisted” or barred from bidding by the GOP or any of its agencies, offices, corporations, or LGUs, including foreign government/foreign or international financing institution whose blacklisting rules have been recognized by the GPPB;
- (f) Ensuring that each of the documents submitted in satisfaction of the bidding requirements is an authentic copy of the original, complete, and all statements and information provided therein are true and correct;
- (g) Authorizing the Head of the Procuring Entity or its duly authorized representative/s to verify all the documents submitted;
- (h) Ensuring that the signatory is the duly authorized representative of the Bidder, and granted full power and authority to do, execute and perform any and all acts necessary and/or to represent the Bidder in the bidding, with the duly notarized Secretary’s Certificate attesting to such fact, if the Bidder is a corporation, partnership, cooperative, or joint venture;
- (i) Complying with the disclosure provision under Section 47 of RA 9184 in relation to other provisions of RA 3019; and
- (j) Complying with existing labor laws and standards, in the case of procurement of services.

Failure to observe any of the above responsibilities shall be at the risk of the Bidder concerned.

- 6.3. The Bidder is expected to examine all instructions, forms, terms, and specifications in the Bidding Documents.
- 6.4. It shall be the sole responsibility of the Bidder to determine and to satisfy itself by such means as it considers necessary or desirable as to all matters pertaining to the contract to be bid, including: (a) the location and the nature of this Project; (b) climatic conditions; (c) transportation facilities; and (d) other factors that may affect the cost, duration, and execution or implementation of this Project.
- 6.5. The Procuring Entity shall not assume any responsibility regarding erroneous interpretations or conclusions by the prospective or eligible bidder out of the data furnished by the procuring entity.
- 6.6. The Bidder shall bear all costs associated with the preparation and submission of his bid, and the Procuring Entity will in no case be responsible or liable for those costs, regardless of the conduct or outcome of the bidding process.

- 6.7. Before submitting their bids, the Bidder is deemed to have become familiar with all existing laws, decrees, ordinances, acts and regulations of the Philippines which may affect this Project in any way.
- 6.8. The Bidder should note that the Procuring Entity will accept bids only from those that have paid the nonrefundable fee for the Bidding Documents at the office indicated in the Invitation to Bid.

7. Origin of Goods

Unless otherwise indicated in the **BDS**, there is no restriction on the origin of goods other than those prohibited by a decision of the United Nations Security Council taken under Chapter VII of the Charter of the United Nations, subject to **ITB** Clause 27.1.

8. Subcontracts

- 8.1. Unless otherwise specified in the **BDS**, the Bidder may subcontract portions of the Goods to an extent as may be approved by the Procuring Entity and stated in the **BDS**. However, subcontracting of any portion shall not relieve the Bidder from any liability or obligation that may arise from the contract for this Project.
- 8.2. Subcontractors must comply with the eligibility criteria and the documentary requirements specified in the **BDS**. In the event that any subcontractor is found by the Procuring Entity to be ineligible, the subcontracting of such portion of the Goods shall be disallowed.
- 8.3. The Bidder may identify the subcontractor to whom a portion of the Goods will be subcontracted at any stage of the bidding process or during contract implementation. If the Bidder opts to disclose the name of the subcontractor during bid submission, the Bidder shall include the required documents as part of the technical component of its bid.

Contents of Bidding Documents

9. Pre-Bid Conference

- 9.1. (a) If so specified in the **BDS**, a pre-bid conference shall be held at the venue and on the date indicated therein, to clarify and address the Bidders' questions on the technical and financial components of this Project.

(b) The pre-bid conference shall be held at least twelve (12) calendar days before the deadline for the submission and receipt of bids. If the Procuring Entity determines that, by reason of the method, nature, or complexity of the contract to be bid, or when international participation will be more advantageous to the GOP, a longer period for the preparation of bids is necessary, the pre-bid conference shall be held at least thirty (30) calendar

*days before the deadline for the submission and receipt of bids, as specified in the **BDS**.*

- 9.2. Bidders are encouraged to attend the pre-bid conference to ensure that they fully understand the Procuring Entity's requirements. Non-attendance of the Bidder will in no way prejudice its bid; however, the Bidder is expected to know the changes and/or amendments to the Bidding Documents discussed during the pre-bid conference.
- 9.3. Any statement made at the pre-bid conference shall not modify the terms of the Bidding Documents unless such statement is specifically identified in writing as an amendment thereto and issued as a Supplemental/Bid Bulletin.

10. Clarification and Amendment of Bidding Documents

- 10.1. Bidders who have purchased the Bidding Documents may request for clarification on any part of the Bidding Documents for an interpretation. Such request must be in writing and submitted to the Procuring Entity at the address indicated in the **BDS** at least ten (10) calendar days before the deadline set for the submission and receipt of bids.
- 10.2. Supplemental/Bid Bulletins may be issued upon the Procuring Entity's initiative for purposes of clarifying or modifying any provision of the Bidding Documents not later than seven (7) calendar days before the deadline for the submission and receipt of bids. Any modification to the Bidding Documents shall be identified as an amendment.
- 10.3. Any Supplemental/Bid Bulletin issued by the BAC shall also be posted on the Philippine Government Electronic Procurement System (PhilGEPS) and the website of the Procuring Entity concerned, if available. It shall be the responsibility of all Bidders who secure the Bidding Documents to inquire and secure Supplemental/Bid Bulletins that may be issued by the BAC. However, Bidders who have submitted bids before the issuance of the Supplemental/Bid Bulletin must be informed and allowed to modify or withdraw their bids in accordance with **ITB** Clause 23.

Preparation of Bids

11. Language of Bid

The bid, as well as all correspondence and documents relating to the bid exchanged by the Bidder and the Procuring Entity, shall be written in English. Supporting documents and printed literature furnished by the Bidder may be in another language provided they are accompanied by an accurate translation in English certified by the appropriate embassy or consulate in the Philippines, in which case the English translation shall govern for purposes of interpretation of the bid.

12. Documents Comprising the Bid: Eligibility and Technical Components

12.1. Unless otherwise indicated in the **BDS**, the first envelope shall contain the following eligibility and technical documents:

(a) Eligibility Documents –

Class “A” Documents:

- (i) Registration certificate from the Securities and Exchange Commission (SEC), Department of Trade and Industry (DTI) for sole proprietorship, or Cooperative Development Authority (CDA) for cooperatives, or any proof of such registration as stated in the **BDS**;
- (ii) Mayor’s permit issued by the city or municipality where the principal place of business of the prospective bidder is located;
- (iii) Statement of all its ongoing and completed government and private contracts within the period stated in the **BDS**, including contracts awarded but not yet started, if any. The statement shall include, for each contract, the following:
 - (iii.1) name of the contract;
 - (iii.2) date of the contract;
 - (iii.3) kinds of Goods;
 - (iii.4) amount of contract and value of outstanding contracts;
 - (iii.5) date of delivery; and
 - (iii.6) end user’s acceptance or official receipt(s) issued for the contract, if completed.
- (iv) Audited financial statements, stamped “received” by the Bureau of Internal Revenue (BIR) or its duly accredited and authorized institutions, for the preceding calendar year, which should not be earlier than two (2) years from bid submission;
- (v) NFCC computation in accordance with **ITB** Clause 5.5;
- (vi) Tax Clearance per Executive Order 398, series of 2005, as finally reviewed and approved by the BIR; and

Class "B" Document:

- (vii) If applicable, the JVA in case the joint venture is already in existence, or duly notarized statements from all the potential joint venture partners stating that they will enter into and abide by the provisions of the JVA in the instance that the bid is successful.
- (b) Technical Documents –
 - (i) Bid security in accordance with **ITB** Clause 18. If the Bidder opts to submit the bid security in the form of:
 - (i.1) a bank draft/guarantee or an irrevocable letter of credit issued by a foreign bank, it shall be accompanied by a confirmation from a Universal or Commercial Bank; or
 - (i.2) a surety bond, it shall be accompanied by a certification by the Insurance Commission that the surety or insurance company is authorized to issue such instruments;
 - (ii) Conformity with technical specifications, as enumerated and specified in Sections VI and VII of the Bidding Documents; and
 - (iii) Sworn statement in accordance with Section 25.2(a)(iv) of the IRR of RA 9184 and using the form prescribed in Section VIII. Bidding Forms.

13. Documents Comprising the Bid: Financial Component

- 13.1. Unless otherwise stated in the **BDS**, the financial component of the bid shall contain the following:
 - (a) Financial Bid Form, which includes bid prices and the bill of quantities and the applicable Price Schedules, in accordance with **ITB** Clauses 15.1 and 15.4;
 - (b) If the Bidder claims preference as a Domestic Bidder or Domestic Entity, a certification from the DTI, SEC, or CDA issued in accordance with **ITB** Clause 27, unless otherwise provided in the **BDS**; and
 - (c) Any other document related to the financial component of the bid as stated in the **BDS**.
- 13.2. (a) Unless otherwise stated in the **BDS**, all bids that exceed the ABC shall not be accepted.

- (b) Unless otherwise indicated in the **BDS**, for foreign-funded procurement, a ceiling may be applied to bid prices provided the following conditions are met:
- (i) Bidding Documents are obtainable free of charge on a freely accessible website. If payment of Bidding Documents is required by the procuring entity, payment could be made upon the submission of bids.
 - (ii) The procuring entity has procedures in place to ensure that the ABC is based on recent estimates made by the responsible unit of the procuring entity and that the estimates reflect the quality, supervision and risk and inflationary factors, as well as prevailing market prices, associated with the types of works or goods to be procured.
 - (iii) The procuring entity has trained cost estimators on estimating prices and analyzing bid variances.
 - (iv) The procuring entity has established a system to monitor and report bid prices relative to ABC and engineer's/procuring entity's estimate.
 - (v) The procuring entity has established a system to monitor and report bid prices relative to ABC and procuring entity's estimate. The procuring entity has established a monitoring and evaluation system for contract implementation to provide a feedback on actual total costs of goods and works.

14. Alternative Bids

Alternative Bids shall be rejected. For this purpose, alternative bid is an offer made by a Bidder in addition or as a substitute to its original bid which may be included as part of its original bid or submitted separately therewith for purposes of bidding. A bid with options is considered an alternative bid regardless of whether said bid proposal is contained in a single envelope or submitted in two (2) or more separate bid envelopes.

15. Bid Prices

- 15.1. The Bidder shall complete the appropriate Price Schedules included herein, stating the unit prices, total price per item, the total amount and the expected countries of origin of the Goods to be supplied under this Project.
- 15.2. The Bidder shall fill in rates and prices for all items of the Goods described in the Bill of Quantities. Bids not addressing or providing all of the required items in the Bidding Documents including, where applicable, Bill of Quantities, shall be considered non-responsive and, thus, automatically disqualified. In this regard, where a required item is

provided, but no price is indicated, the same shall be considered as non-responsive, but specifying a "0" (zero) for the said item would mean that it is being offered for free to the Government.

15.3. The terms Ex Works (EXW), Cost, Insurance and Freight (CIF), Cost and Insurance Paid to (CIP), Delivered Duty Paid (DDP), and other trade terms used to describe the obligations of the parties, shall be governed by the rules prescribed in the current edition of the International Commercial Terms (INCOTERMS) published by the International Chamber of Commerce, Paris.

15.4. Prices indicated on the Price Schedule shall be entered separately in the following manner:

(a) For Goods offered from within the Procuring Entity's country:

(i) The price of the Goods quoted EXW (ex works, ex factory, ex warehouse, ex showroom, or off-the-shelf, as applicable), including all customs duties and sales and other taxes already paid or payable:

(i.1) on the components and raw material used in the manufacture or assembly of Goods quoted ex works or ex factory; or

(i.2) on the previously imported Goods of foreign origin quoted ex warehouse, ex showroom, or off-the-shelf and any Procuring Entity country sales and other taxes which will be payable on the Goods if the contract is awarded.

(ii) The price for inland transportation, insurance, and other local costs incidental to delivery of the Goods to their final destination.

(iii) The price of other (incidental) services, if any, listed in the **BDS**.

(b) For Goods offered from abroad:

(i) Unless otherwise stated in the **BDS**, the price of the Goods shall be quoted DDP with the place of destination in the Philippines as specified in the **BDS**. In quoting the price, the Bidder shall be free to use transportation through carriers registered in any eligible country. Similarly, the Bidder may obtain insurance services from any eligible source country.

(ii) The price of other (incidental) services, if any, listed in the **BDS**.

- 15.5. Prices quoted by the Bidder shall be fixed during the Bidder's performance of the contract and not subject to variation or price escalation on any account. A bid submitted with an adjustable price quotation shall be treated as non-responsive and shall be rejected, pursuant to **ITB** Clause 24.

All bid prices shall be considered as fixed prices, and therefore not subject to price escalation during contract implementation, except under extraordinary circumstances. Extraordinary circumstances refer to events that may be determined by the National Economic and Development Authority in accordance with the Civil Code of the Philippines, and upon the recommendation of the Procuring Entity. Nevertheless, in cases where the cost of the awarded contract is affected by any applicable new laws, ordinances, regulations, or other acts of the GOP, promulgated after the date of bid opening, a contract price adjustment shall be made or appropriate relief shall be applied on a no loss-no gain basis.

16. Bid Currencies

- 16.1. Prices shall be quoted in the following currencies:
- (a) For Goods that the Bidder will supply from within the Philippines, the prices shall be quoted in Philippine Pesos.
 - (b) For Goods that the Bidder will supply from outside the Philippines, the prices may be quoted in the currency(ies) stated in the **BDS**. However, for purposes of bid evaluation, bids denominated in foreign currencies shall be converted to Philippine currency based on the exchange rate as published in the BSP reference rate bulletin on the day of the bid opening.
- 16.2. If so allowed in accordance with **ITB** Clause 16.1, the Procuring Entity for purposes of bid evaluation and comparing the bid prices will convert the amounts in various currencies in which the bid price is expressed to Philippine Pesos at the foregoing exchange rates.
- 16.3. Unless otherwise specified in the **BDS**, payment of the contract price shall be made in Philippine Pesos.

17. Bid Validity

- 17.1. Bids shall remain valid for the period specified in the **BDS** which shall not exceed one hundred twenty (120) calendar days from the date of the opening of bids.
- 17.2. In exceptional circumstances, prior to the expiration of the Bid validity period, the Procuring Entity may request Bidders to extend the period of validity of their bids. The request and the responses shall be made in writing. The bid security described in **ITB** Clause 18 should also be extended corresponding to the extension of the bid validity period at the

least. A Bidder may refuse the request without forfeiting its bid security, but his bid shall no longer be considered for further evaluation and award. A Bidder granting the request shall not be required or permitted to modify its bid.

18. Bid Security

- 18.1. The bid security in the amount stated in the **BDS** shall be equal to the percentage of the ABC in accordance with the following schedule:

Form of Bid Security	Amount of Bid Security (Equal to Percentage of the ABC)
(a) Cash or cashier's/manager's check issued by a Universal or Commercial Bank.	Two percent (2%)
(b) Bank draft/guarantee or irrevocable letter of credit issued by a Universal or Commercial Bank: Provided, however, that it shall be confirmed or authenticated by a Universal or Commercial Bank, if issued by a foreign bank.	
(c) Surety bond callable upon demand issued by a surety or insurance company duly certified by the Insurance Commission as authorized to issue such security.	Five percent (5%)
(d) Any combination of the foregoing.	Proportionate to share of form with respect to total amount of security
(e) Bid Securing Declaration	

For biddings conducted by LGUs, the Bidder may also submit bid securities in the form of cashier's/manager's check, bank draft/guarantee, or irrevocable letter of credit from other banks certified by the BSP as authorized to issue such financial statement.

- 18.2. The bid security should be valid for the period specified in the **BDS**. Any bid not accompanied by an acceptable bid security shall be rejected by the Procuring Entity as non-responsive.
- 18.3. No bid securities shall be returned to bidders after the opening of bids and before contract signing, except to those that failed or declared as post-disqualified, upon submission of a written waiver of their right to file a motion for reconsideration and/or protest. Without prejudice on its forfeiture, bid securities shall be returned only after the bidder with the

Lowest Calculated and Responsive Bid has signed the contract and furnished the performance security, but in no case later than the expiration of the bid security validity period indicated in **ITB** Clause 18.2.

18.4. Upon signing and execution of the contract pursuant to **ITB** Clause 32, and the posting of the performance security pursuant to **ITB** Clause 33, the successful Bidder's bid security will be discharged, but in no case later than the bid security validity period as indicated in the **ITB** Clause 18.2.

18.5. The bid security may be forfeited:

- (a) if a Bidder:
 - (i) withdraws its bid during the period of bid validity specified in **ITB** Clause 17;
 - (ii) does not accept the correction of errors pursuant to **ITB** Clause 28.3(b);
 - (iii) fails to submit the requirements within the prescribed period or a finding against their veracity as stated in **ITB** Clause 29.2;
 - (iv) submission of eligibility requirements containing false information or falsified documents;
 - (v) submission of bids that contain false information or falsified documents, or the concealment of such information in the bids in order to influence the outcome of eligibility screening or any other stage of the public bidding;
 - (vi) allowing the use of one's name, or using the name of another for purposes of public bidding;
 - (vii) withdrawal of a bid, or refusal to accept an award, or enter into contract with the Government without justifiable cause, after the Bidder had been adjudged as having submitted the Lowest Calculated and Responsive Bid;
 - (viii) refusal or failure to post the required performance security within the prescribed time;
 - (ix) refusal to clarify or validate in writing its bid during post-qualification within a period of seven (7) calendar days from receipt of the request for clarification;
 - (x) any documented attempt by a bidder to unduly influence the outcome of the bidding in his favor;
 - (xi) failure of the potential joint venture partners to enter into the joint venture after the bid is declared successful; or

- (xii) all other acts that tend to defeat the purpose of the competitive bidding, such as habitually withdrawing from bidding, submitting late Bids or patently insufficient bid, for at least three (3) times within a year, except for valid reasons.
- (b) if the successful Bidder:
 - (i) fails to sign the contract in accordance with **ITB** Clause 32; or
 - (ii) fails to furnish performance security in accordance with **ITB** Clause 33.

19. Format and Signing of Bids

- 19.1. Bidders shall submit their bids through their duly authorized representative using the appropriate forms provided in Section VIII. Bidding Forms on or before the deadline specified in the **ITB** Clauses 21 in two (2) separate sealed bid envelopes, and which shall be submitted simultaneously. The first shall contain the technical component of the bid, including the eligibility requirements under **ITB** Clause 12.1, and the second shall contain the financial component of the bid.
- 19.2. Forms as mentioned in **ITB** Clause 19.1 must be completed without any alterations to their format, and no substitute form shall be accepted. All blank spaces shall be filled in with the information requested.
- 19.3. The Bidder shall prepare and submit an original of the first and second envelopes as described in **ITB** Clauses 12 and 13. In the event of any discrepancy between the original and the copies, the original shall prevail.
- 19.4. The bid, except for unamended printed literature, shall be signed, and each and every page thereof shall be initialed, by the duly authorized representative/s of the Bidder.
- 19.5. Any interlineations, erasures, or overwriting shall be valid only if they are signed or initialed by the duly authorized representative/s of the Bidder.

20. Sealing and Marking of Bids

- 20.1. Bidders shall enclose their original eligibility and technical documents described in **ITB** Clause 12 in one sealed envelope marked "ORIGINAL - TECHNICAL COMPONENT", and the original of their financial component in another sealed envelope marked "ORIGINAL - FINANCIAL COMPONENT", sealing them all in an outer envelope marked "ORIGINAL BID".
- 20.2. Each copy of the first and second envelopes shall be similarly sealed duly marking the inner envelopes as "COPY NO. ___ - TECHNICAL COMPONENT" and "COPY NO. ___ - FINANCIAL COMPONENT" and the

outer envelope as "COPY NO. ___", respectively. These envelopes containing the original and the copies shall then be enclosed in one single envelope.

- 20.3. The original and the number of copies of the Bid as indicated in the **BDS** shall be typed or written in indelible ink and shall be signed by the bidder or its duly authorized representative/s.
- 20.4. All envelopes shall:
- (a) contain the name of the contract to be bid in capital letters;
 - (b) bear the name and address of the Bidder in capital letters;
 - (c) be addressed to the Procuring Entity's BAC in accordance with **ITB** Clause 1.1;
 - (d) bear the specific identification of this bidding process indicated in the **ITB** Clause 1.2; and
 - (e) bear a warning "DO NOT OPEN BEFORE..." the date and time for the opening of bids, in accordance with **ITB** Clause 21.
- 20.5. If bids are not sealed and marked as required, the Procuring Entity will assume no responsibility for the misplacement or premature opening of the bid.

Submission and Opening of Bids

21. Deadline for Submission of Bids

Bids must be received by the Procuring Entity's BAC at the address and on or before the date and time indicated in the **BDS**.

22. Late Bids

Any bid submitted after the deadline for submission and receipt of bids prescribed by the Procuring Entity, pursuant to **ITB** Clause 21, shall be declared "Late" and shall not be accepted by the Procuring Entity.

23. Modification and Withdrawal of Bids

- 23.1. The Bidder may modify its bid after it has been submitted; provided that the modification is received by the Procuring Entity prior to the deadline prescribed for submission and receipt of bids. The Bidder shall not be allowed to retrieve its original bid, but shall be allowed to submit another bid equally sealed, properly identified, linked to its original bid marked as "TECHNICAL MODIFICATION" or "FINANCIAL MODIFICATION" and stamped "received" by the BAC. Bid modifications received after the

applicable deadline shall not be considered and shall be returned to the Bidder unopened.

- 23.2. A Bidder may, through a Letter of Withdrawal, withdraw its bid after it has been submitted, for valid and justifiable reason; provided that the Letter of Withdrawal is received by the Procuring Entity prior to the deadline prescribed for submission and receipt of bids.
- 23.3. Bids requested to be withdrawn in accordance with **ITB** Clause 23.1 shall be returned unopened to the Bidders. A Bidder may also express its intention not to participate in the bidding through a letter which should reach and be stamped by the BAC before the deadline for submission and receipt of bids. A Bidder that withdraws its bid shall not be permitted to submit another bid, directly or indirectly, for the same contract.
- 23.4. No bid may be modified after the deadline for submission of bids. No bid may be withdrawn in the interval between the deadline for submission of bids and the expiration of the period of bid validity specified by the Bidder on the Financial Bid Form. Withdrawal of a bid during this interval shall result in the forfeiture of the Bidder's bid security, pursuant to **ITB** Clause 18.5, and the imposition of administrative, civil and criminal sanctions as prescribed by RA 9184 and its IRR.

24. Opening and Preliminary Examination of Bids

- 24.1. The BAC shall open the first bid envelopes of Bidders in public as specified in the **BDS** to determine each Bidder's compliance with the documents prescribed in **ITB** Clause 12. For this purpose, the BAC shall check the submitted documents of each bidder against a checklist of required documents to ascertain if they are all present, using a non-discretionary "pass/fail" criterion. If a bidder submits the required document, it shall be rated "passed" for that particular requirement. In this regard, bids that fail to include any requirement or are incomplete or patently insufficient shall be considered as "failed". Otherwise, the BAC shall rate the said first bid envelope as "passed".
- 24.2. Unless otherwise specified in the BDS, immediately after determining compliance with the requirements in the first envelope, the BAC shall forthwith open the second bid envelope of each remaining eligible bidder whose first bid envelope was rated "passed". The second envelope of each complying bidder shall be opened within the same day. In case one or more of the requirements in the second envelope of a particular bid is missing, incomplete or patently insufficient, and/or if the submitted total bid price exceeds the ABC unless otherwise provided in **ITB** Clause 13.2, the BAC shall rate the bid concerned as "failed". Only bids that are determined to contain all the bid requirements for both components shall be rated "passed" and shall immediately be considered for evaluation and comparison.

- 24.3. Letters of withdrawal shall be read out and recorded during bid opening, and the envelope containing the corresponding withdrawn bid shall be returned to the Bidder unopened. If the withdrawing Bidder's representative is in attendance, the original bid and all copies thereof shall be returned to the representative during the bid opening. If the representative is not in attendance, the bid shall be returned unopened by registered mail. The Bidder may withdraw its bid prior to the deadline for the submission and receipt of bids, provided that the corresponding Letter of Withdrawal contains a valid authorization requesting for such withdrawal, subject to appropriate administrative sanctions.
- 24.4. If a Bidder has previously secured a certification from the Procuring Entity to the effect that it has previously submitted the above-enumerated Class "A" Documents, the said certification may be submitted in lieu of the requirements enumerated in **ITB** Clause 12.1(a), items (i) to (v).
- 24.5. In the case of an eligible foreign Bidder as described in **ITB** Clause 5, the Class "A" Documents described in **ITB** Clause 12.1(a) may be substituted with the appropriate equivalent documents, if any, issued by the country of the foreign Bidder concerned.
- 24.6. Each partner of a joint venture agreement shall likewise submit the requirements in **ITB** Clauses 12.1(a)(i) and 12.1(a)(ii). Submission of documents required under **ITB** Clauses 12.1(a)(iii) to 12.1(a)(v) by any of the joint venture partners constitutes compliance.
- 24.7. A Bidder determined as "failed" has three (3) calendar days upon written notice or, if present at the time of bid opening, upon verbal notification, within which to file a request or motion for reconsideration with the BAC: Provided, however, that the motion for reconsideration shall not be granted if it is established that the finding of failure is due to the fault of the Bidder concerned: Provided, further, that the BAC shall decide on the request for reconsideration within seven (7) calendar days from receipt thereof. If a failed Bidder signifies his intent to file a motion for reconsideration, the BAC shall keep the bid envelopes of the said failed Bidder unopened and/or duly sealed until such time that the motion for reconsideration or protest has been resolved.
- 24.8. The Procuring Entity shall prepare the minutes of the proceedings of the bid opening that shall include, as a minimum: (a) names of Bidders, their bid price, bid security, findings of preliminary examination; and (b) attendance sheet. The BAC members shall sign the abstract of bids as read.

Evaluation and Comparison of Bids

25. Process to be Confidential

- 25.1. Members of the BAC, including its staff and personnel, as well as its Secretariat and TWG, are prohibited from making or accepting any kind of

communication with any bidder regarding the evaluation of their bids until the issuance of the Notice of Award, unless otherwise allowed in the case of **ITB** Clause 26.

- 25.2. Any effort by a bidder to influence the Procuring Entity in the Procuring Entity's decision in respect of bid evaluation, bid comparison or contract award will result in the rejection of the Bidder's bid.

26. Clarification of Bids

To assist in the evaluation, comparison, and post-qualification of the bids, the Procuring Entity may ask in writing any Bidder for a clarification of its bid. All responses to requests for clarification shall be in writing. Any clarification submitted by a Bidder in respect to its bid and that is not in response to a request by the Procuring Entity shall not be considered.

27. Domestic Preference

- 27.1. Unless otherwise stated in the **BDS**, the Procuring Entity will grant a margin of preference for the purpose of comparison of bids in accordance with the following:

- (a) The preference shall be applied when (i) the lowest Foreign Bid is lower than the lowest bid offered by a Domestic Bidder, or (ii) the lowest bid offered by a non-Philippine national is lower than the lowest bid offered by a Domestic Entity.
- (b) For evaluation purposes, the lowest Foreign Bid or the bid offered by a non-Philippine national shall be increased by fifteen percent (15%).
- (c) In the event that (i) the lowest bid offered by a Domestic Entity does not exceed the lowest Foreign Bid as increased, or (ii) the lowest bid offered by a non-Philippine national as increased, then the Procuring Entity shall award the contract to the Domestic Bidder/Entity at the amount of the lowest Foreign Bid or the bid offered by a non-Philippine national, as the case may be.
- (d) If the Domestic Entity/Bidder refuses to accept the award of contract at the amount of the Foreign Bid or bid offered by a non-Philippine national within two (2) calendar days from receipt of written advice from the BAC, the Procuring Entity shall award to the bidder offering the Foreign Bid or the non-Philippine national, as the case may be, subject to post-qualification and submission of all the documentary requirements under these Bidding Documents.

- 27.2. A Bidder may be granted preference as a Domestic Entity subject to the certification from the DTI (in case of sole proprietorships), SEC (in case of partnerships and corporations), or CDA (in case of cooperatives) that the

(a) sole proprietor is a citizen of the Philippines or the partnership, corporation, cooperative, or association is duly organized under the laws of the Philippines with at least seventy five percent (75%) of its interest or outstanding capital stock belonging to citizens of the Philippines, (b) habitually established in business and habitually engaged in the manufacture or sale of the merchandise covered by his bid, and (c) the business has been in existence for at least five (5) consecutive years prior to the advertisement and/or posting of the Invitation to Bid for this Project.

- 27.3. A Bidder may be granted preference as a Domestic Bidder subject to the certification from the DTI that the Bidder is offering unmanufactured articles, materials or supplies of the growth or production of the Philippines, or manufactured articles, materials, or supplies manufactured or to be manufactured in the Philippines substantially from articles, materials, or supplies of the growth, production, or manufacture, as the case may be, of the Philippines.

28. Detailed Evaluation and Comparison of Bids

- 28.1. The Procuring Entity will undertake the detailed evaluation and comparison of bids which have passed the opening and preliminary examination of bids, pursuant to **ITB** Clause 24, in order to determine the Lowest Calculated Bid.

- 28.2. The Lowest Calculated Bid shall be determined in two steps:

- (a) The detailed evaluation of the financial component of the bids, to establish the correct calculated prices of the bids; and
- (b) The ranking of the total bid prices as so calculated from the lowest to the highest. The bid with the lowest price shall be identified as the Lowest Calculated Bid.

- 28.3. The Procuring Entity's BAC shall immediately conduct a detailed evaluation of all bids rated "passed," using non-discretionary pass/fail criteria. Unless otherwise specified in the **BDS**, the BAC shall consider the following in the evaluation of bids:

- (a) Completeness of the bid. Unless the ITB specifically allows partial bids, bids not addressing or providing all of the required items in the Schedule of Requirements including, where applicable, bill of quantities, shall be considered non-responsive and, thus, automatically disqualified. In this regard, where a required item is provided, but no price is indicated, the same shall be considered as non-responsive, but specifying a "0" (zero) for the said item would mean that it is being offered for free to the Procuring Entity; and
- (b) Arithmetical corrections. Consider computational errors and omissions to enable proper comparison of all eligible bids. It may

also consider bid modifications, if allowed in the **BDS**. Any adjustment shall be calculated in monetary terms to determine the calculated prices.

- 28.4. Based on the detailed evaluation of bids, those that comply with the above-mentioned requirements shall be ranked in the ascending order of their total calculated bid prices, as evaluated and corrected for computational errors, discounts and other modifications, to identify the Lowest Calculated Bid. Total calculated bid prices, as evaluated and corrected for computational errors, discounts and other modifications, which exceed the ABC shall not be considered, unless otherwise indicated in the **BDS**.
- 28.5. The Procuring Entity's evaluation of bids shall only be based on the bid price quoted in the Financial Bid Form.
- 28.6. Bids shall be evaluated on an equal footing to ensure fair competition. For this purpose, all bidders shall be required to include in their bids the cost of all taxes, such as, but not limited to, value added tax (VAT), income tax, local taxes, and other fiscal levies and duties which shall be itemized in the bid form and reflected in the detailed estimates. Such bids, including said taxes, shall be the basis for bid evaluation and comparison.

29. Post-Qualification

- 29.1. The Procuring Entity shall determine to its satisfaction whether the Bidder that is evaluated as having submitted the Lowest Calculated Bid (LCB) complies with and is responsive to all the requirements and conditions specified in **ITB** Clauses 5, 12, and 13.
- 29.2. Within a non-extendible period of three (3) calendar days from receipt by the bidder of the notice from the BAC that it submitted the LCB, the Bidder shall submit the following documentary requirements:
 - (a) Latest income and business tax returns in the form specified in the **BDS**;
 - (b) Certificate of PhilGEPS Registration; and
 - (c) Other appropriate licenses and permits required by law and stated in the **BDS**.

Failure of the Bidder declared as Lowest Calculated Bid to duly submit the requirements under this Clause or a finding against the veracity of such shall be ground for forfeiture of the bid security and disqualification of the Bidder for award.

- 29.3. The determination shall be based upon an examination of the documentary evidence of the Bidder's qualifications submitted pursuant to **ITB** Clauses 12 and 13, as well as other information as the Procuring

Entity deems necessary and appropriate, using a non-discretionary “pass/fail” criterion.

- 29.4. If the BAC determines that the Bidder with the Lowest Calculated Bid passes all the criteria for post-qualification, it shall declare the said bid as the Lowest Calculated Responsive Bid, and recommend to the Head of the Procuring Entity the award of contract to the said Bidder at its submitted price or its calculated bid price, whichever is lower.
- 29.5. A negative determination shall result in rejection of the Bidder’s Bid, in which event the Procuring Entity shall proceed to the next Lowest Calculated Bid to make a similar determination of that Bidder’s capabilities to perform satisfactorily. If the second Bidder, however, fails the post qualification, the procedure for post qualification shall be repeated for the Bidder with the next Lowest Calculated Bid, and so on until the Lowest Calculated Responsive Bid is determined for contract award.
- 29.6. Within a period not exceeding seven (7) calendar days from the date of receipt of the recommendation of the BAC, the Head of the Procuring Entity shall approve or disapprove the said recommendation. In the case of GOCCs and GFIs, the period provided herein shall be fifteen (15) calendar days.

30. Reservation Clause

- 30.1. Notwithstanding the eligibility or post-qualification of a Bidder, the Procuring Entity concerned reserves the right to review its qualifications at any stage of the procurement process if it has reasonable grounds to believe that a misrepresentation has been made by the said Bidder, or that there has been a change in the Bidder’s capability to undertake the project from the time it submitted its eligibility requirements. Should such review uncover any misrepresentation made in the eligibility and bidding requirements, statements or documents, or any changes in the situation of the Bidder which will affect its capability to undertake the project so that it fails the preset eligibility or bid evaluation criteria, the Procuring Entity shall consider the said Bidder as ineligible and shall disqualify it from submitting a bid or from obtaining an award or contract.
- 30.2. Based on the following grounds, the Procuring Entity reserves the right to reject any and all bids, declare a failure of bidding at any time prior to the contract award, or not to award the contract, without thereby incurring any liability, and make no assurance that a contract shall be entered into as a result of the bidding:
 - (a) If there is *prima facie* evidence of collusion between appropriate public officers or employees of the Procuring Entity, or between the BAC and any of the Bidders, or if the collusion is between or among the bidders themselves, or between a Bidder and a third

party, including any act which restricts, suppresses or nullifies or tends to restrict, suppress or nullify competition;

- (b) If the Procuring Entity's BAC is found to have failed in following the prescribed bidding procedures; or
 - (c) For any justifiable and reasonable ground where the award of the contract will not redound to the benefit of the GOP as follows:
 - (i) If the physical and economic conditions have significantly changed so as to render the project no longer economically, financially or technically feasible as determined by the head of the procuring entity;
 - (ii) If the project is no longer necessary as determined by the head of the procuring entity; and
 - (iii) If the source of funds for the project has been withheld or reduced through no fault of the Procuring Entity.
- 30.3. In addition, the Procuring Entity may likewise declare a failure of bidding when:
- (a) No bids are received;
 - (b) All prospective Bidders are declared ineligible;
 - (c) All bids fail to comply with all the bid requirements or fail post-qualification; or
 - (d) The Bidder with the Lowest Calculated Responsive Bid (LCRB) refuses, without justifiable cause to accept the award of contract, and no award is made.

Award of Contract

31. Contract Award

- 31.1. Subject to **ITB** Clause 29, the Procuring Entity shall award the contract to the Bidder whose bid has been determined to be the LCRB.
- 31.2. Prior to the expiration of the period of bid validity, the Procuring Entity shall notify the successful Bidder in writing that its bid has been accepted, through a Notice of Award received personally or sent by registered mail or electronically, receipt of which must be confirmed in writing within two (2) days by the Bidder with the LCRB and submitted personally or sent by registered mail or electronically to the Procuring Entity.
- 31.3. Notwithstanding the issuance of the Notice of Award, award of contract shall be subject to the following conditions:

- (a) Submission of the valid JVA, if applicable, within ten (10) calendar days from receipt by the Bidder of the notice from the BAC that the Bidder has the LCRB;
 - (b) Posting of the performance security in accordance with **ITB** Clause 33;
 - (c) Signing of the contract as provided in **ITB** Clause 32; and
 - (d) Approval by higher authority, if required.
- 31.4. At the time of contract award, the Procuring Entity shall not increase or decrease the quantity of goods originally specified in Section VI. Schedule of Requirements.

32. Signing of the Contract

- 32.1. At the same time as the Procuring Entity notifies the successful Bidder that its bid has been accepted, the Procuring Entity shall send the Contract Form to the Bidder, which contract has been provided in the Bidding Documents, incorporating therein all agreements between the parties.
- 32.2. Within ten (10) calendar days from receipt of the Notice of Award, the successful Bidder shall post the required performance security and sign and date the contract and return it to the Procuring Entity.
- 32.3. The Procuring Entity shall enter into contract with the successful Bidder within the same ten (10) calendar day period provided that all the documentary requirements are complied with.
- 32.4. The following documents shall form part of the contract:
- (a) Contract Agreement;
 - (b) Bidding Documents;
 - (c) Winning bidder's bid, including the Technical and Financial Proposals, and all other documents/statements submitted;
 - (d) Performance Security;
 - (e) NFCC in accordance with **ITB** Clause 5.5, if applicable;
 - (f) Notice of Award of Contract; and
 - (g) Other contract documents that may be required by existing laws and/or specified in the **BDS**.

33. Performance Security

- 33.1. To guarantee the faithful performance by the winning Bidder of its obligations under the contract, it shall post a performance security within a maximum period of ten (10) calendar days from the receipt of the Notice of Award from the Procuring Entity and in no case later than the signing of the contract.
- 33.2. The performance security shall be denominated in Philippine Pesos and posted in favor of the Procuring Entity in an amount equal to the percentage of the total contract price in accordance with the following schedule:

Form of Performance Security	Amount of Performance Security (Equal to Percentage of the Total Contract Price)
(a) Cash or cashier's/manager's check issued by a Universal or Commercial Bank.	Five percent (5%)
(b) Bank draft/guarantee or irrevocable letter of credit issued by a Universal or Commercial Bank: Provided, however, that it shall be confirmed or authenticated by a Universal or Commercial Bank, if issued by a foreign bank.	
(c) Surety bond callable upon demand issued by a surety or insurance company duly certified by the Insurance Commission as authorized to issue such security; and/or	Thirty percent (30%)
(d) Any combination of the foregoing.	Proportionate to share of form with respect to total amount of security

- 33.3. Failure of the successful Bidder to comply with the above-mentioned requirement shall constitute sufficient ground for the annulment of the award and forfeiture of the bid security, in which event the Procuring Entity shall initiate and complete the post qualification of the second Lowest Calculated Bid. The procedure shall be repeated until the LCRB is identified and selected for contract award. However if no Bidder passed post-qualification, the BAC shall declare the bidding a failure and conduct a re-bidding with re-advertisement.

34. Notice to Proceed

- 34.1. Within three (3) calendar days from the date of approval of the contract by the appropriate government approving authority, the Procuring Entity shall issue its Notice to Proceed to the Bidder.
- 34.2. The contract effectivity date shall be provided in the Notice to Proceed by the Procuring Entity, which date shall not be later than seven (7) calendar days from the issuance of the Notice to Proceed.

Section III. Bid Data Sheet

ITB Clause	
1.1	The Procuring Entity is the ROAD BOARD .
1.2	The project is not divided into lots .
2	The Funding Source is the Government of the Philippines (GOP) through the MVUC Special Road Safety Fund (Fund 153) for CY 2014 in the amount of One Hundred Twenty Million Nine Hundred Forty-Nine Thousand One Hundred Ninety-Seven Pesos and 24/100 (Php120,949,197.24) . The name of the Project is Supply and Delivery of Road Signages along National Roads Nationwide (Package 1B-Warning Signs) .
3.1	No further instructions.
5.1	No further instructions.
5.1 (e)	No further instructions.
5.2	None of the circumstances mentioned in the ITB Clause exists in this Project. Foreign bidders, except those falling under ITB Clause 5.2(b) may not participate in this Project.
5.4	The bidder must have completed prior to the deadline for the submission and receipt of bids a single contract that is similar to the contract to be bid, whose value, adjusted to current prices using the National Statistics Office (NSO) consumer price indices, must be at least fifty percent (50%) of the ABC . <i>For this purpose, supply and delivery of all kinds of road safety signages, not to include guardrails, thermoplastic pavement markings and other road safety devices.</i>
7	No further instructions.
8.1	Subcontracting is not allowed.
8.2	Not applicable.
9.1(a)	The Road Board will hold a Pre-Bid Conference for this Project on November 12, 2014 (Wednesday) 10:00 AM at the RBS Conference Room, 4th Floor Ave Maria Building, 1517 Quezon Avenue cor. Examiner St., Quezon City .
10.1	The Procuring Entity's address is 2nd Floor Ave Maria Building, 1517 Quezon Avenue cor. Examiner St., Quezon City . <u>Mr. Retchie O. Almeda</u> Tel. No. (02) 376-62-69 Fax No. (02) 376-90-28
12.1	Refer to Checklist of Requirements for documentary and tabbing requirements in Section VIII. Bidding Forms.
12.1(a)(i)	No other acceptable proof of registration is recognized.
12.1(a)(iii)	The statement of all ongoing and completed government and private contracts shall include all such contracts prior to the deadline for the submission and receipt of bids .
13.1	No additional requirements.

13.1(b)	No further instructions.
13.1(c)	No additional requirements.
13.2(a)	The ABC is One Hundred Twenty Million Nine Hundred Forty-Nine Thousand One Hundred Ninety-Seven Pesos and 24/100 (Php120,949,197.24) . Any bid with a financial component exceeding this amount is shall not be accepted.
13.2(b)	Not applicable.
15.4(a)(iii)	No incidental services are required.
15.4(b)(i)	For Goods Offered from Abroad, the price shall be quoted DDP-DPWH Regional Offices as presented in Section VI. Schedule of Requirements.
15.4(a)(iii)	No incidental services are required.
16.1(b)	The Bid Prices for Goods supplied from outside of the Philippines shall be quoted in Philippine Pesos.
16.3	No further instructions.
17.1	Bids will be valid for 120 calendar days from opening of bids.
18.1	The bid security shall be in the following amount: <ol style="list-style-type: none"> 1. The amount of Php2,418,983.94 [2% of ABC], if bid security is in cash, cashier's/manager's check, bank draft/guarantee or irrevocable letter of credit; 2. The amount of Php6,047,459.86 [5% of ABC] if bid security is in Surety Bond; or 3. Any combination of the foregoing proportionate to the share of form with respect to total amount of security. 4. Bid Securing Declaration is acceptable.
18.2	The bid security shall be valid for 120 calendar days from bid opening.
20.3	Each Bidder shall submit one (1) original and four (4) certified true copies of the first and second components of its bid. <p>If the document is issued for general purpose (i.e mayor's permit, SEC registration), original shall mean certified true copy of the original as authenticated by the issuing agencies/authorities. For verification, it is recommended that prospective bidders bring the original documents during the bid opening.</p> <p>For documents issued for specific purpose, submit the original as is.</p> <p>The following shall be signed by the bidder's authorized representative. Non-compliance results to disqualification.</p> <ul style="list-style-type: none"> • the marking on the face of each sealed inner envelope (containing the technical eligibility and financial proposals respectively)

	<ul style="list-style-type: none"> • the marking on the sealed outer envelope (containing the sealed inner envelope) • every single page of the technical and financial proposals
21	<p>The address for submission of bids is 4th Floor Ave Maria Building, 1517 Quezon Avenue cor. Examiner St., Quezon City.</p> <p>The deadline for submission of bids is November 24, 2014 (Monday) 12:00:00 noon (PST).</p>
24.1	<p>The place of bid opening is RBS Conference Room, 4th Floor Ave Maria Building, 1517 Quezon Avenue cor. Examiner St., Quezon City.</p> <p>The date and time of bid opening is on November 24, 2014 (Monday) 1:00 PM.</p>
24.2	No further instructions.
27.1	No further instructions.
28.3	The goods are grouped in a single lot and the lot shall not be divided into sub-lots for the purpose of bidding, evaluation, and contract award.
28.3(b)	Bid modification is not allowed.
28.4	No further instructions.
29.2(a)	VAT and Income Tax Return filed and paid electronically within the last six (6) months preceding the date of bid submission.
29.2(c)	No other requirement.
32.4(g)	No other requirement.

Section IV. General Conditions of Contract

TABLE OF CONTENTS

1. DEFINITIONS	43
2. CORRUPT, FRAUDULENT, COLLUSIVE, AND COERCIVE PRACTICES	44
3. INSPECTION AND AUDIT BY THE FUNDING SOURCE.....	45
4. GOVERNING LAW AND LANGUAGE	45
5. NOTICES	46
6. SCOPE OF CONTRACT	46
7. SUBCONTRACTING.....	46
8. PROCURING ENTITY’S RESPONSIBILITIES.....	46
9. PRICES.....	47
10. PAYMENT	47
11. ADVANCE PAYMENT AND TERMS OF PAYMENT.....	47
12. TAXES AND DUTIES.....	48
13. PERFORMANCE SECURITY	48
14. USE OF CONTRACT DOCUMENTS AND INFORMATION.....	49
15. STANDARDS.....	49
16. INSPECTION AND TESTS	49
17. WARRANTY.....	50
18. DELAYS IN THE SUPPLIER’S PERFORMANCE	51
19. LIQUIDATED DAMAGES.....	51
20. SETTLEMENT OF DISPUTES.....	52
21. LIABILITY OF THE SUPPLIER.....	52
22. FORCE MAJEURE	52
23. TERMINATION FOR DEFAULT	53
24. TERMINATION FOR INSOLVENCY.....	54
25. TERMINATION FOR CONVENIENCE	54

26. TERMINATION FOR UNLAWFUL ACTS.....	54
27. PROCEDURES FOR TERMINATION OF CONTRACTS.....	55
28. ASSIGNMENT OF RIGHTS.....	56
29. CONTRACT AMENDMENT	56
30. APPLICATION	56

1. Definitions

1.1. In this Contract, the following terms shall be interpreted as indicated:

- (a) "The Contract" means the agreement entered into between the Procuring Entity and the Supplier, as recorded in the Contract Form signed by the parties, including all attachments and appendices thereto and all documents incorporated by reference therein.
- (b) "The Contract Price" means the price payable to the Supplier under the Contract for the full and proper performance of its contractual obligations.
- (c) "The Goods" means all of the supplies, equipment, machinery, spare parts, other materials and/or general support services which the Supplier is required to provide to the Procuring Entity under the Contract.
- (d) "The Services" means those services ancillary to the supply of the Goods, such as transportation and insurance, and any other incidental services, such as installation, commissioning, provision of technical assistance, training, and other such obligations of the Supplier covered under the Contract.
- (e) "GCC" means the General Conditions of Contract contained in this Section.
- (f) "SCC" means the Special Conditions of Contract.
- (g) "The Procuring Entity" means the organization purchasing the Goods, as named in the **SCC**.
- (h) "The Procuring Entity's country" is the Philippines.
- (i) "The Supplier" means the individual contractor, manufacturer distributor, or firm supplying/manufacturing the Goods and Services under this Contract and named in the **SCC**.
- (j) The "Funding Source" means the organization named in the **SCC**.
- (k) "The Project Site," where applicable, means the place or places named in the **SCC**.
- (l) "Day" means calendar day.
- (m) The "Effective Date" of the contract will be the date of receipt by the Supplier of the Notice to Proceed or the date provided in the Notice to Proceed. Performance of all obligations shall be reckoned from the Effective Date of the Contract.

- (n) "Verified Report" refers to the report submitted by the Implementing Unit to the Head of the Procuring Entity setting forth its findings as to the existence of grounds or causes for termination and explicitly stating its recommendation for the issuance of a Notice to Terminate.

2. Corrupt, Fraudulent, Collusive, and Coercive Practices

2.1. Unless otherwise provided in the **SCC**, the Procuring Entity as well as the bidders, contractors, or suppliers shall observe the highest standard of ethics during the procurement and execution of this Contract. In pursuance of this policy, the Procuring Entity:

- (a) defines, for the purposes of this provision, the terms set forth below as follows:
 - (i) "corrupt practice" means behavior on the part of officials in the public or private sectors by which they improperly and unlawfully enrich themselves, others, or induce others to do so, by misusing the position in which they are placed, and it includes the offering, giving, receiving, or soliciting of anything of value to influence the action of any such official in the procurement process or in contract execution; entering, on behalf of the Government, into any contract or transaction manifestly and grossly disadvantageous to the same, whether or not the public officer profited or will profit thereby, and similar acts as provided in Republic Act 3019.
 - (ii) "fraudulent practice" means a misrepresentation of facts in order to influence a procurement process or the execution of a contract to the detriment of the Procuring Entity, and includes collusive practices among Bidders (prior to or after bid submission) designed to establish bid prices at artificial, non-competitive levels and to deprive the Procuring Entity of the benefits of free and open competition.
 - (iii) "collusive practices" means a scheme or arrangement between two or more Bidders, with or without the knowledge of the Procuring Entity, designed to establish bid prices at artificial, non-competitive levels.
 - (iv) "coercive practices" means harming or threatening to harm, directly or indirectly, persons, or their property to influence their participation in a procurement process, or affect the execution of a contract;

- (v) “obstructive practice” is
 - (aa) deliberately destroying, falsifying, altering or concealing of evidence material to an administrative proceedings or investigation or making false statements to investigators in order to materially impede an administrative proceedings or investigation of the Procuring Entity or any foreign government/foreign or international financing institution into allegations of a corrupt, fraudulent, coercive or collusive practice; and/or threatening, harassing or intimidating any party to prevent it from disclosing its knowledge of matters relevant to the administrative proceedings or investigation or from pursuing such proceedings or investigation; or
 - (bb) acts intended to materially impede the exercise of the inspection and audit rights of the Procuring Entity or any foreign government/foreign or international financing institution herein.
- (b) will reject a proposal for award if it determines that the Bidder recommended for award has engaged in any of the practices mentioned in this Clause for purposes of competing for the contract.

2.2. Further the Funding Source, Borrower or Procuring Entity, as appropriate, will seek to impose the maximum civil, administrative and/or criminal penalties available under the applicable law on individuals and organizations deemed to be involved with any of the practices mentioned in GCC Clause 2.1(a).

3. Inspection and Audit by the Funding Source

The Supplier shall permit the Funding Source to inspect the Supplier’s accounts and records relating to the performance of the Supplier and to have them audited by auditors appointed by the Funding Source, if so required by the Funding Source.

4. Governing Law and Language

- 4.1. This Contract shall be interpreted in accordance with the laws of the Republic of the Philippines.
- 4.2. This Contract has been executed in the English language, which shall be the binding and controlling language for all matters relating to the meaning or interpretation of this Contract. All correspondence and other documents pertaining to this Contract exchanged by the parties shall be written in English.

5. Notices

- 5.1. Any notice, request, or consent required or permitted to be given or made pursuant to this Contract shall be in writing. Any such notice, request, or consent shall be deemed to have been given or made when received by the concerned party, either in person or through an authorized representative of the Party to whom the communication is addressed, or when sent by registered mail, telex, telegram, or facsimile to such Party at the address specified in the **SCC**, which shall be effective when delivered and duly received or on the notice's effective date, whichever is later.
- 5.2. A Party may change its address for notice hereunder by giving the other Party notice of such change pursuant to the provisions listed in the **SCC** for **GCC** Clause 5.1.

6. Scope of Contract

- 6.1. The GOODS and Related Services to be provided shall be as specified in Section VI. Schedule of Requirements.
- 6.2. This Contract shall include all such items, although not specifically mentioned, that can be reasonably inferred as being required for its completion as if such items were expressly mentioned herein. Any additional requirements for the completion of this Contract shall be provided in the **SCC**.

7. Subcontracting

- 7.1. Subcontracting of any portion of the Goods, if allowed in the **BDS**, does not relieve the Supplier of any liability or obligation under this Contract. The Supplier will be responsible for the acts, defaults, and negligence of any subcontractor, its agents, servants or workmen as fully as if these were the Supplier's own acts, defaults, or negligence, or those of its agents, servants or workmen.
- 7.2. Subcontractors disclosed and identified during the bidding may be changed during the implementation of this Contract, subject to compliance with the required qualifications and the approval of the Procuring Entity.

8. Procuring Entity's Responsibilities

- 8.1. Whenever the performance of the obligations in this Contract requires that the Supplier obtain permits, approvals, import, and other licenses from local public authorities, the Procuring Entity shall, if so needed by the Supplier, make its best effort to assist the Supplier in complying with such requirements in a timely and expeditious manner.
- 8.2. The Procuring Entity shall pay all costs involved in the performance of its responsibilities in accordance with **GCC** Clause 6.

9. Prices

- 9.1. For the given scope of work in this Contract as awarded, all bid prices are considered fixed prices, and therefore not subject to price escalation during contract implementation, except under extraordinary circumstances and upon prior approval of the GPPB in accordance with Section 61 of R.A. 9184 and its IRR or except as provided in this Clause.
- 9.2. Prices charged by the Supplier for Goods delivered and/or services performed under this Contract shall not vary from the prices quoted by the Supplier in its bid, with the exception of any change in price resulting from a Change Order issued in accordance with **GCC** Clause 29.

10. Payment

- 10.1. Payments shall be made only upon a certification by the Head of the Procuring Entity to the effect that the Goods have been rendered or delivered in accordance with the terms of this Contract and have been duly inspected and accepted. Except with the prior approval of the President no payment shall be made for services not yet rendered or for supplies and materials not yet delivered under this Contract. Ten percent (10%) of the amount of each payment shall be retained by the Procuring Entity to cover the Supplier's warranty obligations under this Contract as described in **GCC** Clause 17.
- 10.2. The Supplier's request(s) for payment shall be made to the Procuring Entity in writing, accompanied by an invoice describing, as appropriate, the Goods delivered and/or Services performed, and by documents submitted pursuant to the **SCC** provision for **GCC** Clause 6.2, and upon fulfillment of other obligations stipulated in this Contract.
- 10.3. Pursuant to **GCC** Clause 10.2, payments shall be made promptly by the Procuring Entity, but in no case later than sixty (60) days after submission of an invoice or claim by the Supplier.
- 10.4. Unless otherwise provided in the **SCC**, the currency in which payment is made to the Supplier under this Contract shall be in Philippine Pesos.

11. Advance Payment and Terms of Payment

- 11.1. Advance payment shall be made only after prior approval of the President, and shall not exceed fifteen percent (15%) of the Contract amount, unless otherwise directed by the President or in cases allowed under Annex "D" of RA 9184.
- 11.2. For Goods supplied from abroad, the terms of payment shall be as follows:
 - (a) On Contract Signature: Ten percent (10%) of the Contract Price shall be paid within sixty (60) days from signing of the Contract and upon submission of a claim and a bank guarantee for the

equivalent amount valid until the Goods are delivered and in the form provided in Section VIII. Bidding Forms.

- (b) On Delivery: Seventy percent (70%) of the Contract Price shall be paid to the Supplier within sixty (60) days after the date of receipt of the Goods and upon submission of the documents (i) through (vi) specified in the SCC provision on Delivery and Documents.
- (c) On Acceptance: The remaining twenty percent (20%) of the Contract Price shall be paid to the Supplier within sixty (60) days after the date of submission of the acceptance and inspection certificate for the respective delivery issued by the Procuring Entity's authorized representative. In the event that no inspection or acceptance certificate is issued by the Procuring Entity's authorized representative within forty five (45) days of the date shown on the delivery receipt the Supplier shall have the right to claim payment of the remaining twenty percent (20%) subject to the Procuring Entity's own verification of the reason(s) for the failure to issue documents (vii) and (viii) as described in the SCC provision on Delivery and Documents.

11.3. All progress payments shall first be charged against the advance payment until the latter has been fully exhausted.

12. Taxes and Duties

The Supplier, whether local or foreign, shall be entirely responsible for all the necessary taxes, stamp duties, license fees, and other such levies imposed for the completion of this Contract.

13. Performance Security

- 13.1. Within ten (10) calendar days from receipt of the Notice of Award from the Procuring Entity but in no case later than the signing of the contract by both parties, the successful Bidder shall furnish the performance security in any the forms prescribed in the **ITB** Clause 33.2.
- 13.2. The performance security posted in favor of the Procuring Entity shall be forfeited in the event it is established that the winning bidder is in default in any of its obligations under the contract.
- 13.3. The performance security shall remain valid until issuance by the Procuring Entity of the Certificate of Final Acceptance.
- 13.4. The performance security may be released by the Procuring Entity and returned to the Supplier after the issuance of the Certificate of Final Acceptance subject to the following conditions:
 - (a) There are no pending claims against the Supplier or the surety company filed by the Procuring Entity;

- (b) The Supplier has no pending claims for labor and materials filed against it; and
- (c) Other terms specified in the **SCC**.

13.5. In case of a reduction of the contract value, the Procuring Entity shall allow a proportional reduction in the original performance security, provided that any such reduction is more than ten percent (10%) and that the aggregate of such reductions is not more than fifty percent (50%) of the original performance security.

14. Use of Contract Documents and Information

- 14.1. The Supplier shall not, except for purposes of performing the obligations in this Contract, without the Procuring Entity's prior written consent, disclose this Contract, or any provision thereof, or any specification, plan, drawing, pattern, sample, or information furnished by or on behalf of the Procuring Entity. Any such disclosure shall be made in confidence and shall extend only as far as may be necessary for purposes of such performance.
- 14.2. Any document, other than this Contract itself, enumerated in **GCC** Clause 14.1 shall remain the property of the Procuring Entity and shall be returned (all copies) to the Procuring Entity on completion of the Supplier's performance under this Contract if so required by the Procuring Entity.

15. Standards

The Goods provided under this Contract shall conform to the standards mentioned in the Section VII. Technical Specifications; and, when no applicable standard is mentioned, to the authoritative standards appropriate to the Goods' country of origin. Such standards shall be the latest issued by the institution concerned.

16. Inspection and Tests

- 16.1. The Procuring Entity or its representative shall have the right to inspect and/or to test the Goods to confirm their conformity to the Contract specifications at no extra cost to the Procuring Entity. The **SCC** and Section VII. Technical Specifications shall specify what inspections and/or tests the Procuring Entity requires and where they are to be conducted. The Procuring Entity shall notify the Supplier in writing, in a timely manner, of the identity of any representatives retained for these purposes.
- 16.2. If applicable, the inspections and tests may be conducted on the premises of the Supplier or its subcontractor(s), at point of delivery, and/or at the goods' final destination. If conducted on the premises of the Supplier or its subcontractor(s), all reasonable facilities and assistance, including

access to drawings and production data, shall be furnished to the inspectors at no charge to the Procuring Entity. The Supplier shall provide the Procuring Entity with results of such inspections and tests.

- 16.3. The Procuring Entity or its designated representative shall be entitled to attend the tests and/or inspections referred to in this Clause provided that the Procuring Entity shall bear all of its own costs and expenses incurred in connection with such attendance including, but not limited to, all traveling and board and lodging expenses.
- 16.4. The Procuring Entity may reject any Goods or any part thereof that fail to pass any test and/or inspection or do not conform to the specifications. The Supplier shall either rectify or replace such rejected Goods or parts thereof or make alterations necessary to meet the specifications at no cost to the Procuring Entity, and shall repeat the test and/or inspection, at no cost to the Procuring Entity, upon giving a notice pursuant to **GCC** Clause 5.
- 16.5. The Supplier agrees that neither the execution of a test and/or inspection of the Goods or any part thereof, nor the attendance by the Procuring Entity or its representative, shall release the Supplier from any warranties or other obligations under this Contract.

17. Warranty

- 17.1. The Supplier warrants that the Goods supplied under the Contract are new, unused, of the most recent or current models, and that they incorporate all recent improvements in design and materials, except when the technical specifications required by the Procuring Entity provides otherwise.
- 17.2. The Supplier further warrants that all Goods supplied under this Contract shall have no defect, arising from design, materials, or workmanship or from any act or omission of the Supplier that may develop under normal use of the supplied Goods in the conditions prevailing in the country of final destination.
- 17.3. In order to assure that manufacturing defects shall be corrected by the Supplier, a warranty shall be required from the Supplier for a minimum period specified in the **SCC**. The obligation for the warranty shall be covered by, at the Supplier's option, either retention money in an amount equivalent to at least ten percent (10%) of the final payment, or a special bank guarantee equivalent to at least ten percent (10%) of the Contract Price or other such amount if so specified in the **SCC**. The said amounts shall only be released after the lapse of the warranty period specified in the **SCC**; provided, however, that the Supplies delivered are free from patent and latent defects and all the conditions imposed under this Contract have been fully met.

- 17.4. The Procuring Entity shall promptly notify the Supplier in writing of any claims arising under this warranty. Upon receipt of such notice, the Supplier shall, within the period specified in the **SCC** and with all reasonable speed, repair or replace the defective Goods or parts thereof, without cost to the Procuring Entity.
- 17.5. If the Supplier, having been notified, fails to remedy the defect(s) within the period specified in **GCC** Clause 17.4, the Procuring Entity may proceed to take such remedial action as may be necessary, at the Supplier's risk and expense and without prejudice to any other rights which the Procuring Entity may have against the Supplier under the Contract and under the applicable law.

18. Delays in the Supplier's Performance

- 18.1. Delivery of the Goods and/or performance of Services shall be made by the Supplier in accordance with the time schedule prescribed by the Procuring Entity in Section VI. Schedule of Requirements.
- 18.2. If at any time during the performance of this Contract, the Supplier or its Subcontractor(s) should encounter conditions impeding timely delivery of the Goods and/or performance of Services, the Supplier shall promptly notify the Procuring Entity in writing of the fact of the delay, its likely duration and its cause(s). As soon as practicable after receipt of the Supplier's notice, and upon causes provided for under **GCC** Clause 22, the Procuring Entity shall evaluate the situation and may extend the Supplier's time for performance, in which case the extension shall be ratified by the parties by amendment of Contract.
- 18.3. Except as provided under **GCC** Clause 22, a delay by the Supplier in the performance of its obligations shall render the Supplier liable to the imposition of liquidated damages pursuant to **GCC** Clause 19, unless an extension of time is agreed upon pursuant to **GCC** Clause 29 without the application of liquidated damages.

19. Liquidated Damages

Subject to **GCC** Clauses 18 and 22, if the Supplier fails to satisfactorily deliver any or all of the Goods and/or to perform the Services within the period(s) specified in this Contract inclusive of duly granted time extensions if any, the Procuring Entity shall, without prejudice to its other remedies under this Contract and under the applicable law, deduct from the Contract Price, as liquidated damages, the applicable rate of one tenth (1/10) of one (1) percent of the cost of the unperformed portion for every day of delay until actual delivery or performance. The maximum deduction shall be ten percent (10%) of the amount of contract. Once the maximum is reached, the Procuring Entity shall rescind the Contract pursuant to **GCC** Clause 23, without prejudice to other courses of action and remedies open to it.

20. Settlement of Disputes

- 20.1. If any dispute or difference of any kind whatsoever shall arise between the Procuring Entity and the Supplier in connection with or arising out of this Contract, the parties shall make every effort to resolve amicably such dispute or difference by mutual consultation.
- 20.2. If after thirty (30) days, the parties have failed to resolve their dispute or difference by such mutual consultation, then either the Procuring Entity or the Supplier may give notice to the other party of its intention to commence arbitration, as hereinafter provided, as to the matter in dispute, and no arbitration in respect of this matter may be commenced unless such notice is given.
- 20.3. Any dispute or difference in respect of which a notice of intention to commence arbitration has been given in accordance with this Clause shall be settled by arbitration. Arbitration may be commenced prior to or after delivery of the Goods under this Contract.
- 20.4. In the case of a dispute between the Procuring Entity and the Supplier, the dispute shall be resolved in accordance with Republic Act 9285 ("R.A. 9285"), otherwise known as the "Alternative Dispute Resolution Act of 2004."
- 20.5. Notwithstanding any reference to arbitration herein, the parties shall continue to perform their respective obligations under the Contract unless they otherwise agree; and the Procuring Entity shall pay the Supplier any monies due the Supplier.

21. Liability of the Supplier

- 21.1. The Supplier's liability under this Contract shall be as provided by the laws of the Republic of the Philippines, subject to additional provisions, if any, set forth in the **SCC**.
- 21.2. Except in cases of criminal negligence or willful misconduct, and in the case of infringement of patent rights, if applicable, the aggregate liability of the Supplier to the Procuring Entity shall not exceed the total Contract Price, provided that this limitation shall not apply to the cost of repairing or replacing defective equipment.

22. Force Majeure

- 22.1. The Supplier shall not be liable for forfeiture of its performance security, liquidated damages, or termination for default if and to the extent that the Supplier's delay in performance or other failure to perform its obligations under the Contract is the result of a *force majeure*.
- 22.2. For purposes of this Contract the terms "*force majeure*" and "fortuitous event" may be used interchangeably. In this regard, a fortuitous event or

force majeure shall be interpreted to mean an event which the Contractor could not have foreseen, or which though foreseen, was inevitable. It shall not include ordinary unfavorable weather conditions; and any other cause the effects of which could have been avoided with the exercise of reasonable diligence by the Contractor. Such events may include, but not limited to, acts of the Procuring Entity in its sovereign capacity, wars or revolutions, fires, floods, epidemics, quarantine restrictions, and freight embargoes.

- 22.3. If a *force majeure* situation arises, the Supplier shall promptly notify the Procuring Entity in writing of such condition and the cause thereof. Unless otherwise directed by the Procuring Entity in writing, the Supplier shall continue to perform its obligations under the Contract as far as is reasonably practical, and shall seek all reasonable alternative means for performance not prevented by the *force majeure*.

23. Termination for Default

- 23.1. The Procuring Entity shall terminate this Contract for default when any of the following conditions attends its implementation:
- (a) Outside of *force majeure*, the Supplier fails to deliver or perform any or all of the Goods within the period(s) specified in the contract, or within any extension thereof granted by the Procuring Entity pursuant to a request made by the Supplier prior to the delay, and such failure amounts to at least ten percent (10%) of the contact price;
 - (b) As a result of *force majeure*, the Supplier is unable to deliver or perform any or all of the Goods, amounting to at least ten percent (10%) of the contract price, for a period of not less than sixty (60) calendar days after receipt of the notice from the Procuring Entity stating that the circumstance of force majeure is deemed to have ceased; or
 - (c) The Supplier fails to perform any other obligation under the Contract.
- 23.2. In the event the Procuring Entity terminates this Contract in whole or in part, for any of the reasons provided under **GCC** Clauses 23 to 26, the Procuring Entity may procure, upon such terms and in such manner as it deems appropriate, Goods or Services similar to those undelivered, and the Supplier shall be liable to the Procuring Entity for any excess costs for such similar Goods or Services. However, the Supplier shall continue performance of this Contract to the extent not terminated.
- 23.3. In case the delay in the delivery of the Goods and/or performance of the Services exceeds a time duration equivalent to ten percent (10%) of the specified contract time plus any time extension duly granted to the Supplier, the Procuring Entity may terminate this Contract, forfeit the

Supplier's performance security and award the same to a qualified Supplier.

24. Termination for Insolvency

The Procuring Entity shall terminate this Contract if the Supplier is declared bankrupt or insolvent as determined with finality by a court of competent jurisdiction. In this event, termination will be without compensation to the Supplier, provided that such termination will not prejudice or affect any right of action or remedy which has accrued or will accrue thereafter to the Procuring Entity and/or the Supplier.

25. Termination for Convenience

25.1. The Procuring Entity may terminate this Contract, in whole or in part, at any time for its convenience. The Head of the Procuring Entity may terminate a contract for the convenience of the Government if he has determined the existence of conditions that make Project Implementation economically, financially or technically impractical and/or unnecessary, such as, but not limited to, fortuitous event(s) or changes in law and national government policies.

25.2. The Goods that have been delivered and/or performed or are ready for delivery or performance within thirty (30) calendar days after the Supplier's receipt of Notice to Terminate shall be accepted by the Procuring Entity at the contract terms and prices. For Goods not yet performed and/or ready for delivery, the Procuring Entity may elect:

- (a) to have any portion delivered and/or performed and paid at the contract terms and prices; and/or
- (b) to cancel the remainder and pay to the Supplier an agreed amount for partially completed and/or performed goods and for materials and parts previously procured by the Supplier.

25.3. If the Supplier suffers loss in its initial performance of the terminated contract, such as purchase of raw materials for goods specially manufactured for the Procuring Entity which cannot be sold in open market, it shall be allowed to recover partially from this Contract, on a *quantum meruit* basis. Before recovery may be made, the fact of loss must be established under oath by the Supplier to the satisfaction of the Procuring Entity before recovery may be made.

26. Termination for Unlawful Acts

26.1. The Procuring Entity may terminate this Contract in case it is determined *prima facie* that the Supplier has engaged, before or during the implementation of this Contract, in unlawful deeds and behaviors relative to contract acquisition and implementation. Unlawful acts include, but are not limited to, the following:

- (a) Corrupt, fraudulent, and coercive practices as defined in **ITB** Clause 3.1(a);
- (b) Drawing up or using forged documents;
- (c) Using adulterated materials, means or methods, or engaging in production contrary to rules of science or the trade; and
- (d) Any other act analogous to the foregoing.

27. Procedures for Termination of Contracts

27.1. The following provisions shall govern the procedures for termination of this Contract:

- (a) Upon receipt of a written report of acts or causes which may constitute ground(s) for termination as aforementioned, or upon its own initiative, the Implementing Unit shall, within a period of seven (7) calendar days, verify the existence of such ground(s) and cause the execution of a Verified Report, with all relevant evidence attached;
- (b) Upon recommendation by the Implementing Unit, the Head of the Procuring Entity shall terminate this Contract only by a written notice to the Supplier conveying the termination of this Contract. The notice shall state:
 - (i) that this Contract is being terminated for any of the ground(s) afore-mentioned, and a statement of the acts that constitute the ground(s) constituting the same;
 - (ii) the extent of termination, whether in whole or in part;
 - (iii) an instruction to the Supplier to show cause as to why this Contract should not be terminated; and
 - (iv) special instructions of the Procuring Entity, if any.
- (c) The Notice to Terminate shall be accompanied by a copy of the Verified Report;
- (d) Within a period of seven (7) calendar days from receipt of the Notice of Termination, the Supplier shall submit to the Head of the Procuring Entity a verified position paper stating why this Contract should not be terminated. If the Supplier fails to show cause after the lapse of the seven (7) day period, either by inaction or by default, the Head of the Procuring Entity shall issue an order terminating this Contract;
- (e) The Procuring Entity may, at any time before receipt of the Supplier's verified position paper described in item (d) above

withdraw the Notice to Terminate if it is determined that certain items or works subject of the notice had been completed, delivered, or performed before the Supplier's receipt of the notice;

- (f) Within a non-extendible period of ten (10) calendar days from receipt of the verified position paper, the Head of the Procuring Entity shall decide whether or not to terminate this Contract. It shall serve a written notice to the Supplier of its decision and, unless otherwise provided, this Contract is deemed terminated from receipt of the Supplier of the notice of decision. The termination shall only be based on the ground(s) stated in the Notice to Terminate;
- (g) The Head of the Procuring Entity may create a Contract Termination Review Committee (CTRC) to assist him in the discharge of this function. All decisions recommended by the CTRC shall be subject to the approval of the Head of the Procuring Entity; and
- (h) The Supplier must serve a written notice to the Procuring Entity of its intention to terminate the contract at least thirty (30) calendar days before its intended termination. The Contract is deemed terminated if it is not resumed in thirty (30) calendar days after the receipt of such notice by the Procuring Entity.

28. Assignment of Rights

The Supplier shall not assign his rights or obligations under this Contract, in whole or in part, except with the Procuring Entity's prior written consent.

29. Contract Amendment

Subject to applicable laws, no variation in or modification of the terms of this Contract shall be made except by written amendment signed by the parties.

30. Application

These General Conditions shall apply to the extent that they are not superseded by provisions of other parts of this Contract.

Section V. Special Conditions of Contract

GCC Clause	
1.1(g)	The Procuring Entity is the ROAD BOARD .
1.1(i)	The Supplier is _____.
1.1(j)	The Funding Source is the Government of the Philippines (GOP) through the MVUC Special Road Safety Fund (Fund 153) for CY 2014 in the amount of One Hundred Twenty Million Nine Hundred Forty-Nine Thousand One Hundred Ninety-Seven Pesos and 24/100 (Php120,949,197.24)
1.1(k)	The Project sites are defined in Section VI. Schedule of Requirements.
2.1	No further instructions.
5.1	<p>The Procuring Entity's address for Notices is 2nd Floor Ave Maria Building, 1517, Quezon Avenue cor. Examiner St., Quezon City.</p> <p><u>Mr. Retchie O. Almeda</u> Tel. No. (02) 376-62-69 Fax No. (02) 376-57-89</p> <p>The Supplier's address for Notices is _____ _____.</p> <p><u>Representative</u> Tel. No. Fax No.</p>
6.2	<p>Delivery and Documents</p> <p>For purposes of the Contract, "EXW," "FOB," "FCA," "CIF," "CIP," "DDP" and other trade terms used to describe the obligations of the parties shall have the meanings assigned to them by the current edition of INCOTERMS published by the International Chamber of Commerce, Paris. The Delivery terms of this Contract shall be as follows:</p> <p><i>For Goods Supplied from Abroad</i>, the delivery terms applicable to the Contract are DDP delivered to project sites presented in Section VI of this bidding document. In accordance with INCOTERMS.</p> <p><i>For Goods Supplied from Within the Philippines</i>, The delivery terms applicable to this Contract are delivered to the same places of destination as above. Risk and title will pass from the Supplier to the Procuring Entity upon receipt and final acceptance of the</p>

Goods at their final destination.

Delivery of the Goods shall be made by the Supplier in accordance with the terms specified in Section VI. Schedule of Requirements. The details of shipping and/or other documents to be furnished by the Supplier are as follows:

For Goods supplied from within the Philippines:

Upon delivery of the Goods to the Project Site, the Supplier shall notify the Procuring Entity and present the following documents to the Procuring Entity:

- (i) Original and four copies of the Supplier's invoice showing Goods' description, quantity, unit price, and total amount;
- (ii) Original and four copies delivery receipt/note, railway receipt, or truck receipt;
- (iii) Original Supplier's factory inspection report;
- (iv) Original and four copies of the Manufacturer's and/or Supplier's warranty certificate;
- (v) Original and four copies of the certificate of origin (for imported Goods);
- (vi) Delivery receipt detailing number and description of items received signed by the authorized receiving personnel;
- (vii) Certificate of Acceptance/Inspection Report signed by the Procuring Entity's representative at the Project Site; and
- (viii) Four copies of the Invoice Receipt for Property signed by the Procuring Entity's representative at the Project Site.

For Goods supplied from abroad:

Upon shipment, the Supplier shall notify the Procuring Entity and the insurance company by cable the full details of the shipment, including Contract Number, description of the Goods, quantity, vessel, bill of lading number and date, port of loading, date of shipment, port of discharge etc. Upon delivery to the Project Site, the Supplier shall notify the Procuring Entity and present the following documents as applicable with the documentary requirements of any letter of credit issued taking precedence:

- (i) Original and four copies of the Supplier's invoice showing Goods' description, quantity, unit price, and total amount;
- (ii) Original and four copies of the negotiable, clean shipped on board bill of lading marked "freight pre-paid" and five copies of the non-negotiable bill of lading ;

- (iii) Original Supplier's factory inspection report;
- (iv) Original and four copies of the Manufacturer's and/or Supplier's warranty certificate;
- (v) Original and four copies of the certificate of origin (for imported Goods);
- (vi) Delivery receipt detailing number and description of items received signed by the Procuring Entity's representative at the Project Site;
- (vii) Certificate of Acceptance/Inspection Report signed by the Procuring Entity's representative at the Project Site; and
- (viii) Four copies of the Invoice Receipt for Property signed by the Procuring Entity's representative at the Project Site.

For purposes of this Clause the Procuring Entity's Representatives at the Project Sites **shall come from the Road Board Secretariat.**

Packaging

The Supplier shall provide such packaging of the Goods as is required to prevent their damage or deterioration during transit to their final destination, as indicated in this Contract. The packaging shall be sufficient to withstand, without limitation, rough handling during transit and exposure to extreme temperatures, salt and precipitation during transit, and open storage. Packaging case size and weights shall take into consideration, where appropriate, the remoteness of the GOODS' final destination and the absence of heavy handling facilities at all points in transit.

Insurance

The Goods supplied under this Contract shall be fully insured by the Supplier in a freely convertible currency against loss or damage incidental to manufacture or acquisition, transportation, storage, and delivery. The Goods remain at the risk and title of the Supplier until their final acceptance by the Procuring Entity.

Transportation

Where the Supplier is required under Contract to deliver the Goods CIF, CIP or DDP, transport of the Goods to the port of destination or such other named place of destination in the Philippines, as shall be specified in this Contract, shall be arranged and paid for by the Supplier, and the cost thereof shall be included in the Contract Price.

	<p>Where the Supplier is required under this Contract to transport the Goods to a specified place of destination within the Philippines, defined as the Project Site, transport to such place of destination in the Philippines, including insurance and storage, as shall be specified in this Contract, shall be arranged by the Supplier, and related costs shall be included in the Contract Price.</p> <p>The Procuring Entity accepts no liability for the damage of Goods during transit other than those prescribed by INCOTERMS for DDP Deliveries. In the case of Goods supplied from within the Philippines or supplied by domestic Suppliers risk and title will not be deemed to have passed to the Procuring Entity until their receipt and final acceptance at the final destination.</p> <p>Patent Rights</p> <p>The Supplier shall indemnify the Procuring Entity against all third-party claims of infringement of patent, trademark, or industrial design rights arising from use of the Goods or any part thereof.</p>
10.4	No additional provision.
13.4(c)	No further instructions.
16.1	<p>The inspections and tests that will be conducted are:</p> <ul style="list-style-type: none"> • Test on material properties, performance, and dimensions (against technical specifications) • Prototype testing of fabricated road sign prior to mass production • Testing of fabricated road signages prior to shipment to point of delivery (sign-dating sticker) • Final inspection of delivered signages to point of delivery
17.3	<p>In order to assure that the manufacturing defects shall be corrected by the supplier, a warranty shall be required from the Supplier for a minimum period of ten (10) years from the date of final acceptance.</p> <p>Release of retention money or special bank guarantee shall be made one (1) year after acceptance by the Procuring Entity of the delivered Goods.</p>
17.4	The period for correction of defects is within 15 calendar days from the receipt of notice of the Procuring Entity.
21.1	No additional provision/All partners to the joint venture shall be jointly and severally liable to the Procuring Entity.

Section VI. Schedule of Requirements

DELIVERY SITE DPWH Regional Office	TYPE AND QUANTITY									TOTAL	DELIVERED ON
	Curve Sign (W1-3)		Winding Road Sign	Cross Road Sign	Priority Road Sign			Narrow Bridge Sign	Divided Road Sign		From Day 1 of Contract as Stated in The NTP
	Right	Left	W1-5	W2-1	W2-8	W2-9	W2-9	W4-1P	W4-3		
NCR	27	27	6	67	114	53	157	6	12	469	Day 135 to 140
CAR	242	242	202	12	50	14	16	10	6	794	Day 143 to 148
RI	134	134	104	34	90	4	4	28	4	536	Day 151 to 156
RII	169	169	90	26	80	20	16	18	2	590	Day 159 to 164
RIII	129	129	86	88	166	38	44	68	12	760	Day 167 to 172
RIV-A	182	182	84	38	44	20	22	38	35	645	Day 175 to 180
RIV-B	158	158	88	18	70	18	20	62	10	602	Day 183 to 188
RV	321	321	280	136	188	26	26	10		1,308	Day 191 to 196
RVI	266	266	210	46	112	278	24	42	36	1,280	Day 199 to 204
RVII	166	166	146	138	208	16	12	84	20	956	Day 207 to 212
RVIII	255	255	132	28	144	16	34	12	20	896	Day 215 to 220
RIX	275	275	130	72	152	22	16	26	30	998	Day 223 to 228
RX	321	321	176	36	174	20	28	15	24	1,115	Day 231 to 236
RXI	286	286	108	44	126	18	20	26	12	926	Day 239 to 244
RXII	92	92	90	82	228	10	14	14	21	643	Day 247 to 252
RXIII	185	185	100	39	194	2	2	14	16	737	Day 255 to 260
TOTAL	3,208	3,208	2,032	904	2,140	575	455	473	260	13,255	

ROAD SIGN	DRAWING	QUANTITY
WARNING SIGNS		
1. Curve, W1-3		3,208
		3,208
2. Winding Road, W1-5		2,032
3. Cross Road, W2-1		904
4. Priority Road		
a. W2-8		2,140
b. W2-9		575
c. W2-10		455
5. Narrow Bridge, W4-1P		473
6. Divided Road, W4-3		260

Section VII. Technical Specifications

A. Description

This Item shall consist of furnishing and installing road signs in accordance with this Specification and to the details shown on the Plans, or as required by the Engineer.

B. Material Requirements

B.1 Sign Panels

Sign panels shall be manufactured from aluminum composite panel.

ALUMINUM COMPOSITE PANEL (ACP)

ACP used for signboard is a sandwich construction with a thermoplastic core of “Low Density Polyethylene” (LDPE) between two thick skins/sheets of aluminum with overall thickness of 4mm, and aluminum skin thickness of 0.4mm on both sides. The retro –reflective sheeting must be applied on the top surface with aluminum surface with recommended surface preparation from sheeting manufacturer. A fluorocarbon coating may be applied over the exposed surface of aluminum to ensure corrosion resistant and weather proof and thus shall conform to relevant ASTM. The mechanical properties of 4mm and that of its aluminum skin shall conform to the requirement given in the table below, when tested in accordance with the test methods mentioned against each of them.

Table 1. Properties of Aluminum Composite Panel

No.	Test Description	Standard Test	4mm ACP Acceptable Value
A	Mechanical Properties of ACP		
1	Peel off strength with retroreflective sheeting. (DRUM Peel Test)	ASTM D903	Min 4N/mm
2	Tensile Strength	ASTM D638	Min 40 N/mm ²
3	0.2% Proof Stress	ASTM D638	Min 34 N/mm ²
4	Elongation	ASTM D638	Min 6%
5	Flexural Strength	ASTM C393	Min 130 N/mm ²
6	Shear strength with punch shear test	ASTM D732	Min 18 N/mm ²
B	Properties of Aluminum Skin		
1	Tensile Strength (Rm)	ASTM E8	Min 150 N/mm ²
2	Modulus of elasticity	ASTM E8	Min 7000 N/mm ²
3	Elongation	ASTM E8	A ₅₀ Min 2%
4	0.2% Proof Stress	ASTM E8	Min 110 N/mm ²

B.2 Retroreflective Sheeting

The retroreflective sheeting shall conform to the requirements of ASTM D 4956-11.

The retroreflective sheeting used on the signs shall consist of white or colored sheeting having smooth outer surface which has the property of retro reflection over its entire surface. It shall be weather resistant and exhibit color fastness. It shall be new and unused or show no evidence of cracking, scaling, and pitting, blistering, edge lifting or curling and shall have negligible shrinkage or expansion.

A certificate of having the sheeting tested for coefficient of retro reflection, day time color and luminance, shrinkage, flexibility, liner removal, adhesion, impact resistance, specular gloss and fungus resistance, 3 years outdoor weathering and its having passed these result shall be obtained from reputed International Laboratory by the manufacturer of retroreflective sheeting strictly as per ASTM D 4956-11.

A retroreflective sheeting typically manufactured as an unmetallized cube corner microprismatic retroreflective element material. The retroreflective surface after cleaning with soap and water and in dry condition shall meet or exceed the minimum coefficient of retro reflection as per Type IX and XI of ASTM D 4956-11. The values are as indicated in the following table:

Table 2. Type IX Sheeting

Chromatic Angle	Emission Angle	White	Yellow	Orange	Green	Red	Blue	Fluorescent Yellow/Green	Fluorescent Yellow	Fluorescent Orange
0.1° ^A	-4°	670	570	450	40	150	50	520	470	400
0.1° ^B	+30°	370	250	140	37	74	17	300	230	110
0.2°	-4°	380	265	145	38	76	17	300	230	115
0.2°	+30°	216	132	82	22	43	10	170	130	66
0.2°	-4°	240	150	90	24	43	11	190	145	72
0.2°	+30°	155	100	50	14	27	6.0	110	77	41
1.0°	-4°	50	30	30	8.0	8	3.6	64	48	24
1.0°	+30°	16	3.1	1.7	1.6	0.6	2.0	35	27	11

^A Minimum Coefficient of Retroreflection (R_A) $cd/fc/ft^2 (cd \cdot lx^{-1} \cdot m^{-2})$.

^B Values for 0.1° observation angles are supplementary requirements that shall apply only when specified by the purchaser in the contract or order.

Table 3. Type XI Sheeting

Observation Angle	Emission Angle	White	Yellow	Orange	Green	Red	Blue	Brown	Fluorescent Yellow/Green	Fluorescent Yellow	Fluorescent Orange
0.1° ^A	-4°	830	650	290	93	125	37	25	680	500	250
0.1° ^B	+31°	325	245	115	23	50	15	10	260	300	150
0.2°	-4°	630	455	200	58	87	23	17	460	350	175
0.2°	+30°	230	155	77	21	30	10	7.0	100	150	65
0.2°	-4°	430	315	150	40	61	19	13	340	250	125
0.2°	+30°	50	110	65	15	23	7.0	5.0	30	90	45
1.0°	-4°	30	90	42	12	2	5.0	4.0	28	72	36
1.0°	+30°	16	3.1	1.5	6.0	7.0	2.0	1.0	35	27	11

^A Minimum Coefficient of Retroreflection (R_A) $cd/fc/ft^2 (cd \cdot lx^{-1} \cdot m^{-2})$.

^B Values for 0.1° observation angles are supplementary requirements that shall apply only when specified by the purchaser in the contract or order.

When totally wet, the sheeting shall show not less than 90% of the values of retro reflection and at the end of 10 years of warranty period, the sheeting shall retain at least 80% of its original retroreflection.

The sheeting shall have a pressure sensitive adhesive of the aggressive tack type requiring no heat, solvent or other preparation of adhesion to a smooth lean surface, in a manner recommended by the sheeting manufacturer. The adhesive shall be protected by an easily removable liner (removable by peeling without soaking in water or other solvent) and shall be suitable for the type of material of the base plate used for the sign. The adhesive shall form a durable bond to smooth, corrosion and weather resistant surface of the base plate such that it shall not be possible to remove the sheeting from the sign base in one piece by use of sharp instrument. The sheeting shall be applied in accordance with the manufacture's application guide.

B.3 Posts, Frames, Bracket, and other accessories.

B.3.1 Posts and Frames

Posts shall be fabricated from structural steel conforming to ASTM A 283 Grade D or tubular steel posts conforming to ASTM A 501. All posts shall be thoroughly cleaned, free from grease, scale and rust and shall be given one coat of rust-inhibiting priming paint and two coats of international orange CMYK: 0, 72, 77, 24.

B.3.2 Bracket Railing/ Stiffener

Bracket railing/ stiffener shall be made of aluminum-alloy 6063 -T5 or higher that conforms to the requirement of ASTM B221, and other ASTM designation as applies.

B.3.3 Other Materials

Material parts (nuts, bolts, washer, bracket, etc.) made of aluminum specified in the plan shall be made of 2024-T4 aluminum or 6061-T6 aluminum or higher conforms to the requirement of ASTM B221, and other ASTM designation as applies.

Material parts made of steel specified in the plan shall be hot-dip galvanized after fabrication in accordance with the requirements of AASHTO M 111.

B.3.4 Double Sided Adhesive Tape

This is a viscoelastic, general purpose acrylic adhesive on a firm type foam tape consists of adhesive, carrier and liner.

B.3.4.1 Composition Requirement

1. Adhesive: acrylic adhesive
2. Carrier: acrylic foam
3. Liner: paper liner

Table 5. Physical Properties

Property Requirement	Values	Standard Test
Thickness: Adhesive + Foam	1.0 mm	ASTM D3652
Foam Density	800 kg/m ³	ASTM D792
90° Peel Adhesion (72 hrs dwell - 300 mm/min)	332N/100 mm	ASTM D 3330
Dynamic Shear (72 hrs dwell - 12.7 mm/min)	550 kPa	ASTM D1002
Static Shear	10,000 mins	ASTM D3654
Normal Tensile (72 hrs dwell - 50 mm/min)	760 kPa	ASTM D897
Temperature		ASTM D3654
Short Term (240 mins)	149°C	
Long Term (10,000 mins)	90°C	

B.3.4.2 Application Technique

Bond strength is dependent upon the amount of adhesive-to-surface contact developed. Firm application pressure and moderate heat, will assist the adhesive in developing intimate contact with the bonding surface. To obtain optimum adhesion performance, the bonding surfaces must be clean, dry, free of grease oil and well unified.

B.3.5 Mounting

The bracket railing shall be mounted to the signboard using a double sided adhesive tape as shown on the plan or welded in accordance with the signboard manufacturer's recommendation.

Specification of tape shall conform to the requirement in B.3.4 Adhesive Tape.

C. Sign Panel Fabrication

Aluminum Surface of the ACP shall be effectively prepared to receive the retroreflective sheeting. This aluminum side of the ACP shall be de-greased either by acid or hot alkaline etching and all scale/ dust removed to obtain a smooth plain surface before the application of retroreflective sheeting. If the surface is rough, approved surface primer may be used. After cleaning, it should not be handled, except by suitable device or clean canvas gloves, between all cleaning and preparation operation and application of reflective sheeting/ primer. There shall be no opportunity for ACP to come in contact with grease, oil or other contaminants prior to the application of retroreflective sheeting. The board should be made of min. joints as much as possible. Complete ACP sheets shall be used on signs except where it is unavoidable. At slices, sheeting with pressure sensitive adhesives shall be overlapped not less than 5mm. Where screen printing with transparent colors is proposed, only butt joint shall used.

The material shall cover the sign surface evenly and shall be free from twists, cracks and folds. Cutouts to produce legends, letters and borders shall be bonded with the sheeting in the manner specified by the retroreflective sheeting manufacturer.

The messages (legends, letters, numerals, etc.) and borders shall be cutouts from the same type of reflective sheeting. Screen printing shall be processed and finished with materials and in a manner specified by the retroreflective sheeting manufacturer. For the informatory and other sign boards, the messages (legends/letters/numerals, etc.) and borders shall be strictly cutouts from the same reflective sheeting only except those in black which shall be of non reflective opaque film .

Signs must be dated at the time of fabrication in order to initiate the 10-year performance warranty. A sign-dating sticker that indicates the project name, contractor/sign maker’s name, sheeting type, sheeting manufacturer/brand name, sheeting series, sheeting lot no., date of fabrication, and property number, should be placed at the back of the sign face.



Sign-dating sticker, 2.0 inches by 3.5 inches laminated sticker



Proof of inspection sticker, 1.0 inch by 1.5 inches

D. Method of Measurement

The quantities shall be the number of such signs of the size specified, including the necessary posts and supports and accepted.

E. Basis of Payment

The quantities measured as determined in Subsection D, Method of Measurement, shall be paid for at the contract unit price for the Pay Items shown in the Bid Schedule which price and payment shall be full compensation for furnishing of road signs, and all labor, equipment, tools and incidentals necessary to complete the Item.

Payment will be made under:

Pay Item No.	Description	Unit of Measurement
605	Road Sign	Each

CURVE SIGN (W1-3)

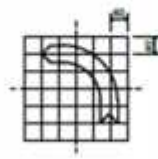

4MM THK. ALUMINUM COMPOSITE PANEL (ACP)
 - NO RIVETS, BLACK LEGENDS WITH RED BORDERS ON RETRO-REFLECTIVE WHITE BACKGROUND



FRONT

Not less than 75mm O.D.
 X 3.75mm thick
 (Painted w/ International Orange)

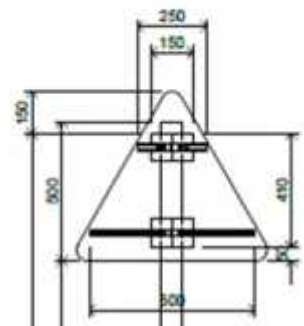

BACK

With G.I. TOP COVER

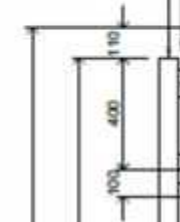

SIDE

- 3mm THK x 100 x 150mm T-BAR WELDED TO G.I. PIPE
- SIGN FACE
- BRACKET RAILING
- 3mm THK ALUMINUM BRACKET w/ 10mm dia. x 1 1/2" Aluminum or Hot-dip Galvanized BOLT, NUT and WASHER

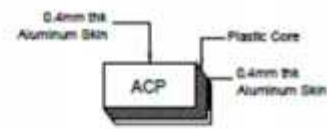
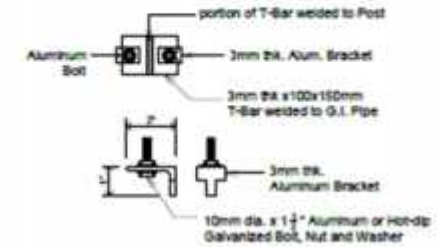

ACP DETAILS

- NOTE:
- 1.) Retro-Reflective materials should be Type (X or XI) Reflective sheeting in accordance with ASTM D4956-11
 - 2.) For Bracket mounting, use Adhesive Tape or welding with 10 years warranty
 - 3.) For Painting of post, use International Orange (CMFK: 0, 72, 77, 24)

	<p>DESCRIPTION</p> <p>W1-3 (CURVE SIGN - LEFT & RIGHT)</p> <ul style="list-style-type: none"> - WARNING SIGN - USED IN ADVANCE OF A SUBSTANDARD CURVE 		<p>DESCRIPTION</p> <p>W2-8 (PRIORITY ROAD SIGN)</p> <ul style="list-style-type: none"> - WARNING SIGN - USED ONLY FOR POSITIVELY CONTROLLED SIDE ROAD IN CONJUNCTION WITH STOP & GIVE WAY SIGN TO AVOID CONFUSION
	<p>DESCRIPTION</p> <p>W1-5 (CURVE SIGN)</p> <ul style="list-style-type: none"> - WARNING SIGN - USED IN ADVANCE OF A CLOSELY SPACED CURVES 	<p style="text-align: center;">W2-9 W2-10</p>	<p>W2-9 (PRIORITY ROAD SIGN)</p> <p>W2-10 (PRIORITY ROAD SIGN)</p>
	<p>DESCRIPTION</p> <p>W2-1 (CROSS ROAD SIGN)</p> <ul style="list-style-type: none"> - WARNING SIGN - BLACK SYMBOL AND BORDER ON RETRO-REFLECTIVE FLOURESCENT YELLOW-GREEN BACKGROUND 		<p>DESCRIPTION</p> <p>W4-3 (DIVIDED ROAD SIGN)</p> <ul style="list-style-type: none"> - WARNING SIGN - USED ONLY FOR APPROACHING MEDIAN ISLAND WITH MORE THAN 300.00 METERS IN LENGTH

NARROW BRIDGE SIGN (W4-1P)



4MM THK ALUMINUM COMPOSITE PANEL (ACP)
- NO RIVETS, BLACK LEGENDS, LETTERS &
NUMERAL BORDERS ON RETRO-REFLECTIVE
WHITE BACKGROUND

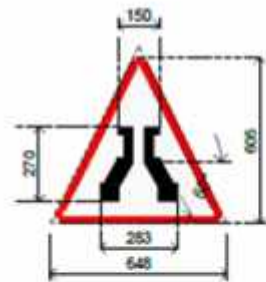

BLACK SYMBOL WITH RED RETRO-REFLECTIVE
BORDER ON RETRO-REFLECTIVE WHITE
BACKGROUND

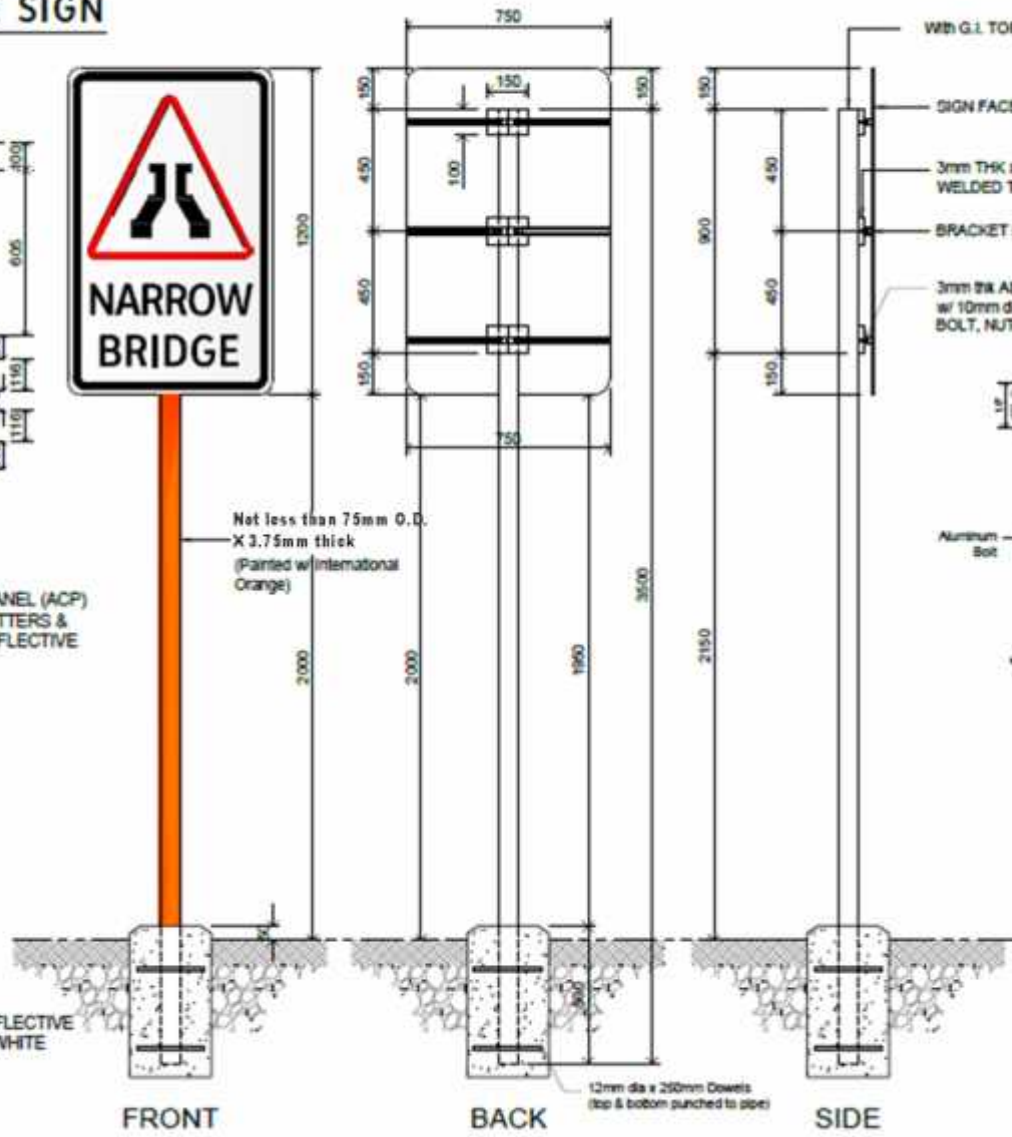

FRONT

BACK

SIDE

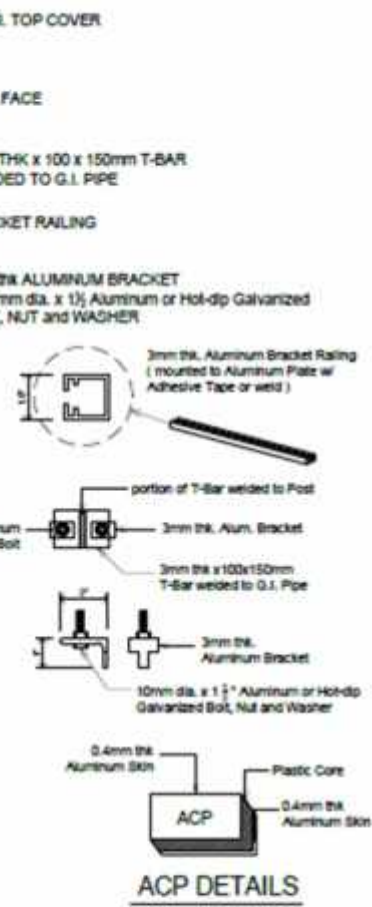

- NOTE:
- 1.) Retro-Reflective materials should be Type IX or XI Reflective sheeting in accordance with ASTM D4956-11
 - 2.) Text, Numerals and Letters shall be in Clearview Highway Font (2-W)
 - 3.) For Bracket mounting, use Adhesive Tape or welding with 10 years warranty
 - 4.) For Painting of post, use International Orange (CMYK: 0, 72, 77, 34)

PREPARED BY : ROAD BOARD / JDC / 20APR14

Section VIII. Bidding Forms

Notes on the Bidding Forms

The Bidder shall complete and submit with its Bid the **Bid Form** and **Price Schedules** in accordance with **ITB** Clause 15 with the requirements of the Bidding Documents and the format set out in this Section.

When requested in the BDS, the Bidder should provide the **Bid Security**, either in the form included hereafter or in another form acceptable to the Entity, pursuant to **ITB** Clause 18.1.

The **Contract Agreement Form**, when it is finalized at the time of contract award, should incorporate any corrections or modifications to the accepted Bid resulting from price corrections. The Price Schedule and Schedule of Requirements deemed to form part of the contract should be modified accordingly.

The **Performance Security Form** and **Bank Guarantee Form for Advance Payment** should not be completed by the Bidders at the time of their Bid preparation. Only the successful Bidder will be required to provide performance security and bank guarantee for advance payment in accordance with one of the forms indicated herein or in another form acceptable to the Procuring Entity and pursuant to **GCC** Clause 13 and its corresponding SCC provision.

The sworn affidavit must be completed by all Bidders in accordance with **ITB** Clause 4.2 failure to do so and submit it with the bid shall result in the rejection of the bid and the Bidder's disqualification.

TABLE OF CONTENTS

BID FORM	70
PRICE SCHEDULE	72
CONTRACT AGREEMENT FORM.....	74
OMNIBUS SWORN STATEMENT.....	75
BANK GUARANTEE FORM FOR ADVANCE PAYMENT	77
BID SECURING DECLARATION.....	78
CERTIFICATE OF AUTHORITY AS CONVERTER/BIDDER.....	80
PROVISIONAL PRE-QUALIFICATION WARRANTY.....	81
DECLARATION FOR 12" x 12" SAMPLE.....	84
DECLARATION TO ISSUE FINAL WARRANTY	85
CHECKLIST OF REQUIREMENTS.....	86
FINANCIAL DOCUMENT FOR ELIGIBILITY CHECK	87
LIST OF ALL ONGOING GOVERNMENT & PRIVATE CONTRACTS INCLUDING CONTRACTS AWARDED BUT NOT YET STARTED.....	88
STATEMENT OF ALL COMPLETED GOVERNMENT & PRIVATE CONTRACTS	89
SEALING AND MARKING OF BIDS (TWO-ENVELOPE SYSTEM)	90

Bid Form

Date: _____
Invitation to Bid¹ N^o: _____

To: *[name and address of Procuring Entity]*

Gentlemen and/or Ladies:

Having examined the Bidding Documents including Bid Bulletin Numbers *[insert numbers]*, the receipt of which is hereby duly acknowledged, we, the undersigned, offer to *[supply/deliver/perform]* *[description of the Goods]* in conformity with the said Bidding Documents for the sum of *[total Bid amount in words and figures]* or such other sums as may be ascertained in accordance with the Schedule of Prices attached herewith and made part of this Bid.

We undertake, if our Bid is accepted, to deliver the goods in accordance with the delivery schedule specified in the Schedule of Requirements.

If our Bid is accepted, we undertake to provide a performance security in the form, amounts, and within the times specified in the Bidding Documents.

We agree to abide by this Bid for the Bid Validity Period specified in **BDS** provision for **ITB** Clause 18.2 and it shall remain binding upon us and may be accepted at any time before the expiration of that period.

Commissions or gratuities, if any, paid or to be paid by us to agents relating to this Bid, and to contract execution if we are awarded the contract, are listed below:²

Name and address of agent	Amount and Currency	Purpose of Commission or gratuity
_____	_____	_____
_____	_____	_____
_____	_____	_____

(if none, state "None")

Until a formal Contract is prepared and executed, this Bid, together with your written acceptance thereof and your Notice of Award, shall be binding upon us.

We understand that you are not bound to accept the lowest or any Bid you may receive.

¹ If ADB, JICA and WB funded projects, use IFB.

² Applicable only if the Funding Source is the ADB, JICA or WB.

We certify/confirm that we comply with the eligibility requirements as per **ITB** Clause 5 of the Bidding Documents.

Dated this _____ day of _____ 20_____.

[signature]

[in the capacity of]

Duly authorized to sign Bid for and on behalf of _____

Price Schedule

For Goods Offered From Abroad

Name of Bidder _____, Invitation to Bid³ Number _____. Page _____ of ____.

1	2	3	4	5	6	7	8	9
Item	Description	Country of origin	Quantity	Unit price CIF port of entry (specify port) or CIP named place (specify border point or place of destination)	Total CIF or CIP price per item (col. 4 x 5)	Unit Price Delivered Duty Unpaid (DDU)	Unit price Delivered Duty Paid (DDP)	Total Price delivered DDP (col 4 x 8)

³ If ADB, JICA and WB funded projects, use IFB.

Price Schedule

For Goods Offered From Within the Philippines

Name of Bidder _____ Invitation to Bid⁴ Number _____. Page . of _____.

1	2	3	4	5	6	7	8	9	10
Item	Description	Country of origin	Quantity	Unit price EXW per item	Cost of local labor, raw material, and component ²	Total price EXW per item (cols. 4 x 5)	Unit prices per item final destination and unit price of other incidental services	Sales and other taxes payable per item if Contract is awarded	Total Price delivered Final Destination (col 8 + 9) x 4

⁴ If ADB, JICA and WB funded projects, use IFB.

Contract Agreement Form

THIS AGREEMENT made the ____ day of _____ 20____ between *[name of PROCURING ENTITY]* of the Philippines (hereinafter called "the Entity") of the one part and *[name of Supplier]* of *[city and country of Supplier]* (hereinafter called "the Supplier") of the other part:

WHEREAS the Entity invited Bids for certain goods and ancillary services, viz., *[brief description of goods and services]* and has accepted a Bid by the Supplier for the supply of those goods and services in the sum of *[contract price in words and figures]* (hereinafter called "the Contract Price").

NOW THIS AGREEMENT WITNESSETH AS FOLLOWS:

1. In this Agreement words and expressions shall have the same meanings as are respectively assigned to them in the Conditions of Contract referred to.
2. The following documents shall be deemed to form and be read and construed as part of this Agreement, viz.:
 - (a) the Bid Form and the Price Schedule submitted by the Bidder;
 - (b) the Schedule of Requirements;
 - (c) the Technical Specifications;
 - (d) the General Conditions of Contract;
 - (e) the Special Conditions of Contract; and
 - (f) the Entity's Notification of Award.
3. In consideration of the payments to be made by the Entity to the Supplier as hereinafter mentioned, the Supplier hereby covenants with the Entity to provide the goods and services and to remedy defects therein in conformity in all respects with the provisions of the Contract
4. The Entity hereby covenants to pay the Supplier in consideration of the provision of the goods and services and the remedying of defects therein, the Contract Price or such other sum as may become payable under the provisions of the contract at the time and in the manner prescribed by the contract.

IN WITNESS whereof the parties hereto have caused this Agreement to be executed in accordance with the laws of the Republic of the Philippines on the day and year first above written.

Signed, sealed, delivered by _____ the _____ (for the Entity)

Signed, sealed, delivered by _____ the _____ (for the Supplier).

Omnibus Sworn Statement

REPUBLIC OF THE PHILIPPINES)
CITY/MUNICIPALITY OF _____) S.S.

AFFIDAVIT

I, *[Name of Affiant]*, of legal age, *[Civil Status]*, *[Nationality]*, and residing at *[Address of Affiant]*, after having been duly sworn in accordance with law, do hereby depose and state that:

1. **Select one, delete the other:**

If a sole proprietorship: I am the sole proprietor of *[Name of Bidder]* with office address at *[address of Bidder]*;

If a partnership, corporation, cooperative, or joint venture: I am the duly authorized and designated representative of *[Name of Bidder]* with office address at *[address of Bidder]*;

2. **Select one, delete the other:**

If a sole proprietorship: As the owner and sole proprietor of *[Name of Bidder]*, I have full power and authority to do, execute and perform any and all acts necessary to represent it in the bidding for *[Name of the Project]* of the *[Name of the Procuring Entity]*;

If a partnership, corporation, cooperative, or joint venture: I am granted full power and authority to do, execute and perform any and all acts necessary and/or to represent the *[Name of Bidder]* in the bidding as shown in the attached *[state title of attached document showing proof of authorization (e.g., duly notarized Secretary's Certificate issued by the corporation or the members of the joint venture)]*;

3. *[Name of Bidder]* is not "blacklisted" or barred from bidding by the Government of the Philippines or any of its agencies, offices, corporations, or Local Government Units, foreign government/foreign or international financing institution whose blacklisting rules have been recognized by the Government Procurement Policy Board;
4. Each of the documents submitted in satisfaction of the bidding requirements is an authentic copy of the original, complete, and all statements and information provided therein are true and correct;
5. *[Name of Bidder]* is authorizing the Head of the Procuring Entity or its duly authorized representative(s) to verify all the documents submitted;

6. **Select one, delete the rest:**

If a sole proprietorship: I am not related to the Head of the Procuring Entity, members of the Bids and Awards Committee (BAC), the Technical Working Group, and the BAC Secretariat, the head of the Project Management Office or the end-user unit, and the project consultants by consanguinity or affinity up to the third civil degree;

If a partnership or cooperative: None of the officers and members of [Name of Bidder] is related to the Head of the Procuring Entity, members of the Bids and Awards Committee (BAC), the Technical Working Group, and the BAC Secretariat, the head of the Project Management Office or the end-user unit, and the project consultants by consanguinity or affinity up to the third civil degree;

If a corporation or joint venture: None of the officers, directors, and controlling stockholders of [Name of Bidder] is related to the Head of the Procuring Entity, members of the Bids and Awards Committee (BAC), the Technical Working Group, and the BAC Secretariat, the head of the Project Management Office or the end-user unit, and the project consultants by consanguinity or affinity up to the third civil degree;

7. [Name of Bidder] complies with existing labor laws and standards; and
8. [Name of Bidder] is aware of and has undertaken the following responsibilities as a Bidder:
- a) Carefully examine all of the Bidding Documents;
 - b) Acknowledge all conditions, local or otherwise, affecting the implementation of the Contract;
 - c) Made an estimate of the facilities available and needed for the contract to be bid, if any; and
 - d) Inquire or secure Supplemental/Bid Bulletin(s) issued for the [Name of the Project].

IN WITNESS WHEREOF, I have hereunto set my hand this __ day of __, 20__ at _____, Philippines.

Bidder's Representative/Authorized Signatory

[JURAT]

* This form will not apply for WB funded projects.

Bank Guarantee Form for Advance Payment

To: *[name and address of PROCURING ENTITY]*
 [name of Contract]

Gentlemen and/or Ladies:

In accordance with the payment provision included in the Special Conditions of Contract, which amends Clause 10 of the General Conditions of Contract to provide for advance payment, *[name and address of Supplier]* (hereinafter called the "Supplier") shall deposit with the PROCURING ENTITY a bank guarantee to guarantee its proper and faithful performance under the said Clause of the Contract in an amount of *[amount of guarantee in figures and words]*.

We, the *[bank or financial institution]*, as instructed by the Supplier, agree unconditionally and irrevocably to guarantee as primary obligator and not as surety merely, the payment to the PROCURING ENTITY on its first demand without whatsoever right of objection on our part and without its first claim to the Supplier, in the amount not exceeding *[amount of guarantee in figures and words]*.

We further agree that no change or addition to or other modification of the terms of the Contract to be performed thereunder or of any of the Contract documents which may be made between the PROCURING ENTITY and the Supplier, shall in any way release us from any liability under this guarantee, and we hereby waive notice of any such change, addition, or modification.

This guarantee shall remain valid and in full effect from the date of the advance payment received by the Supplier under the Contract until *[date]*.

Yours truly,

Signature and seal of the Guarantors

[name of bank or financial institution]

[address]

[date]

REPUBLIC OF THE PHILIPPINES)
CITY OF _____) S.S.

X-----X

BID-SECURING DECLARATION

Invitation to Bid/Request for Expression of Interest No.1: *[Insert reference number]*

To: *[Insert name and address of the Procuring Entity]*

I/We², the undersigned, declare that:

1. I/We understand that, according to your conditions, bids must be supported by a Bid Security, which may be in the form of a Bid-Securing Declaration.
2. I/We accept that: (a) I/we will be automatically disqualified from bidding for any contract with any procuring entity for a period of two (2) years upon receipt of your Blacklisting Order; and, (b) I/we will pay the applicable fine provided under Section 6 of the Guidelines on the Use of Bid Securing Declaration³, if I/we have committed any of the following actions:
 - (i) Withdrawn my/our Bid during the period of bid validity required in the Bidding Documents; or
 - (ii) Fail or refuse to accept the award and enter into contract or perform any and all acts necessary to the execution of the Contract, in accordance with the Bidding Documents after having been notified of your acceptance of our Bid during the period of bid validity.
3. I/We understand that this Bid-Securing Declaration shall cease to be valid on the following circumstances:
 - (a) Upon expiration of the bid validity period, or any extension thereof pursuant to your request;
 - (b) I am/we are declared ineligible or post-disqualified upon receipt of your notice to such effect, and (i) I/we failed to timely file a request for reconsideration or (ii) I/we filed a waiver to avail of said right;
 - (c) I am/we are declared as the bidder with the Lowest Calculated and Responsive Bid/Highest Rated and Responsive Bid⁴, and I/we have furnished the performance security and signed the Contract.

¹ Select one and delete the other.

² Select one and delete the other. Adopt same instruction for similar terms throughout the document.

³ Issued by the GPPB through GPPB Resolution 03-2012 on 27 January 2012.

⁴ Select one and delete the other.

IN WITNESS WHEREOF, I/We have hereunto set my/our hand/s this ____ day of *[month]* *[year]* at *[place of execution]*.

***[Insert NAME OF BIDDER'S
AUTHORIZED REPRESENTATIVE]
[Insert signatory's legal
capacity]***

Affiant

SUBSCRIBED AND SWORN to before me this __ day of *[month]* *[year]* at *[place of execution]*, Philippines. Affiant/s is/are personally known to me and was/were identified by me through competent evidence of identity as defined in the 2004 Rules on Notarial Practice (A.M. No. 02-8-13-SC). Affiant/s exhibited to me his/her *[insert type of government identification card used]*, with his/her photograph and signature appearing thereon, with no. ____ and his/her Community Tax Certificate No. ____ issued on ____ at ____.

Witness my hand and seal this __ day of *[month]* *[year]*.

NAME OF NOTARY PUBLIC

Serial No. of Commission _____

Notary Public for ____ until _____

Roll of Attorneys No. _____

PTR No. __, [date issued], [place issued]

IBP No. __, [date issued], [place issued]

Doc. No. ____

Page No. ____

Book No. ____

Series of ____.

(LOGO OF SHEETING MANUFACTURER)

Issued on: _____

To,
The Director,
Road Board,
Philippines .

Certificate of Authority as Converter/Bidder

Dear Sir,

This is to certify that _____ is an Authorized Converter for road signs using (SHEETING MANUFACTURER'S BRAND NAME) retro-reflective sheeting which meets / exceeds the retroreflective values of Type ____ specifications as per ASTM D4956.

The above certificate is valid for and up to the completion of the bid identified hereunder:

Bid Title :
Bid No. :
Bid Due date :

For (SHEETING MANUFACTURER)

Authorized Signatory

3. When totally wet the sheeting reflectivity is less than 90% of the Initial.

The co-efficient of retro-reflection shall not be less than 50% of the values for the screen-printed areas with transparent screen printing inks on White sheeting for the corresponding colors as mentioned in the table below.

Table No. 1 – Type ____ Sheeting Acceptable Minimum Coefficient of Retro-Reflection for wide angle Micro-Prismatic Type Sheeting Candles per Lux per Sq. Mt.

TABLE 9 Type IX Sheeting¹

Observation Angle	Entrance Angle	White	Yellow	Orange	Green	Red	Blue	Brown	Fluorescent Yellow-Green	Fluorescent Yellow	Fluorescent Orange
0-10°	0°	680	630	360	65	130	20	20	620	400	230
0-15°	-30°	370	250	140	37	74	11	11	300	220	110
0-20°	-40°	320	240	140	36	70	17	17	300	220	110
0-25°	-50°	215	190	87	95	48	10	10	170	190	95
0-35°	-40°	240	150	90	24	48	1	1	120	45	72
0-50°	-30°	135	100	60	17	27	6.0	6.0	110	81	41
1-10°	-40°	20	20	30	5.0	10	3.0	3.0	74	42	24
1-10°	-50°	45	54	17	4.5	9.0	2.0	2.0	90	27	14

¹ Minimum Coefficient of Retro-Reflection (Cd/m²/cd/m²)

² Values for 0° observation angle are supplementary requirements that shall only apply when specified by the purchaser in the contract or order.

TABLE 10 Type XI Sheeting¹

Observation Angle	Entrance Angle	White	Yellow	Orange	Green	Red	Blue	Brown	Fluorescent Yellow-Green	Fluorescent Yellow	Fluorescent Orange
0-10°	0°	530	620	300	82	125	37	36	660	600	280
0-15°	-30°	225	245	115	30	50	15	10	260	200	100
0-20°	-40°	190	460	200	50	27	20	17	400	300	170
0-25°	-50°	220	125	77	29	34	10	7.0	120	120	90
0-35°	-40°	420	315	150	42	23	9	13	340	250	25
0-50°	-30°	150	110	50	15	25	7.0	5.0	150	20	45
1-10°	-40°	120	90	42	9	18	7.0	4.0	50	72	50
1-10°	-50°	47	84	16	7.0	7.0	2.0	1.0	50	27	14

¹ Minimum Coefficient of Retro-Reflection (Cd/m²/cd/m²)

² Values for 0° observation angle are supplementary requirements that shall only apply when specified by the purchaser in the contract or order.

Such failure must be solely the results of defects in Micro Prismatic Type sheeting and not outside causes such as improper storage, handling, maintenance or installation, vandalism or malicious mischief.

- C. When the sheeting has not performed in accordance with the requirement stated in B above, the sheeting manufacturer shall cover the costs of restoring the sign surface to its original effectiveness for sheeting shown to be unsatisfactory and our Authorized Converter/Supplier/Tenderer/Bidder shall replace such defective sign board free of cost.
- D. Sheeting manufacturer has the right to determine the method of restoring the sign surface in consultation with Road Board.
- E. The purchaser shall date all signs at the time of sheeting application, consulting the start of the guarantee period.
- F. The purchaser shall notify the sheeting manufacturer whenever such a “failure” is evident, provide the requested information via the established complaint procedure and permit the sheeting manufacturer to verify the cause of failure.
- G. This provisional prequalification warranty letter shall not apply for the signs fabricated in combination with other sheeting manufacturers and any sign surface which has been chemically damaged or damaged by willful or negligent

mishandling. The sheeting manufacturer liability under this warranty is limited to replacement or allowance as stated herein and the sheeting manufacturer will assume no liability for any direct or consequential expenses or losses.

- H. This provisional prequalification warranty letter is the draft of main warranty which will be issued on the completion of the said work accompanied by lot Certificate. This Warranty is issued in lieu of all other warranties whether expressed or implied.

For, (SHEETING MANUFACTURER)

For, (SHEETING CONVERTER)

Authorized Signatory

Authorized Converter / Bidder

(LOGO OF SHEETING MANUFACTURER)

Ref No. _____
Issued on: _____

To,
The Director,
Road Board,
Philippines .

Declaration for 12" X 12" sample of Retroreflective Sheeting

Dear Sir,

This is to certify that we, (SHEETING MNUFACTURER) are the manufacturer of the attached samples of (SHEETIN MANUFACTURER's BRAND NAME) which meets / exceeds the retroreflective values of Type ____ as per ASTM D 4956.

These samples have been cut and signed for the bid identified hereunder:

Bid Title :
Bid No. :
Bid Due date :

For (SHEETING MANUFACTURER)

Authorized Signatory

(LOGO OF SHEETING MANUFACTURER)

Ref No. _____
Issued on: _____

To,
The Director,
Road Board,
Philippines .

Declaration to Issue the Final Warranty

Dear Sir,

This is to certify that we, (SHEETING MNUFACTURER) along with our Authorized converter _____ are committed to offer the final warranty accompanied with the LOT no. on the completion of the below mentioned bid.

Bid Title :
Bid No. :
Bid Due date :

For (SHEETING MANUFACTURER)

Authorized Signatory



CHECKLIST OF REQUIREMENTS

NUMBER OF COPIES OF BIDDING DOCUMENTS:

One (1) Original copy (Technical and Financial Envelope)

Four (4) Copies of the first and second components of its bid (Technical and Financial Envelope)

PLEASE MAKE USE OF TABS AS SEQUENCED BELOW. FAILURE TO FOLLOW SHALL BE A GROUND FOR DISQUALIFICATION.

TABS	REQUIRED DOCUMENTS	PASS	FAIL
ELIGIBILITY DOCUMENTS			
A	Department of Trade and Industry (DTI) business name registration, SEC Registration or CDA Registration, whichever may be appropriate under existing laws of the Philippines, supported with the necessary information using the prescribed forms		
B	Valid and current Mayor's permit/municipal license		
C	Statement of ongoing and similar completed government and private contracts within the period specified in the IAEB, including contracts awarded but not yet started and percentage of completion for on-going contracts. Include copies of end-user's acceptance or official receipt issued for the contract, if completed		
D	Audited financial statements, stamped "received" by the BIR or its duly accredited and authorized institutions, for the immediately preceding calendar year (2013), showing among others the total assets and liabilities		
E	Computation of Net Financial Contracting Capacity (NFCC)		
F	Tax Clearance per Executive Order 398, series of 2005, as finally reviewed and approved by the BIR/ Delinquency Verification Certificate issued by the BIR (for foreign partner of a JV)		
G	Notarized statements from potential joint venture partners or valid joint venture agreement, in case of a joint venture		
H	Bid Security (For surety bond, attach the issuing agency's Certificate of Authority from the Insurance Commission specific to the project and Official Receipts)		
I	Conformity with technical specifications as enumerated and specified in Sections VI and VII of this Bidding Document (in the form of an Undertaking)		
J	Omnibus Sworn Statement (Sec.25.2 of IRR) – Must include Board Resolution or Secretary's Certificate/ Authority to Sign		
OTHER REQUIREMENTS SPECIFIC TO THE PROJECT			
K	Summary sheet/checklist comparing the specifications as required by the procuring entity (copied from Section VII. TECHNICAL SPECIFICATIONS) and the specifications of the product being offered. Non inclusion shall be a ground for disqualification.		
L	Certificate of Authority as Converter from sheeting manufacturer—Certification from the manufacturer of the retroreflective sheeting that the material to be used for the Project has been tested and is conforming to ASTM D4956. This certificate should be supported with a copy of test results conducted by a reputable local/international laboratory.		
M	Provisional Pre-Qualification Warranty		
N	Test certificates from any recognized national/international laboratories		
O	Declaration for 12" x 12" sample of retroreflective sheeting		
P	Declaration to Issue Final Warranty		
Q	Miniature (scaled prototype) for each type of signage using 1:5M scale		
FINANCIAL PROPOSAL			
R	The financial proposal submission sheet , which includes the bill of quantities and price schedules .		

Financial Documents for Eligibility

A. Summary of the Applicant Supplier’s/Distributor’s/Manufacturer’s assets and liabilities on the basis of the attached income tax return and audited financial statement, stamped “ RECEIVED “ by the Bureau of Internal Revenue or BIR authorized collecting agent, for the immediately preceding year and a certified copy of Schedule of Fixed Assets particularly the list of construction equipment.

		Year 20__
1	Total Assets	
2	Current Assets	
3	Total Liabilities	
4	Current Liabilities	
5	Net Worth (1 – 3)	
6	Net Working Capital (2 – 4)	

B. The Net Financial Contracting Capacity (NFCC) based on the above data is computed as follows:

NFCC = K (current assets – current liabilities) minus value of all outstanding works under contracts including awarded contracts yet to be started

NFCC = P _____

K = 10 for a contract duration of one year or less, 15 for more than one year up to two years and 20 for more than two years

Herewith attached are certified true copies of the income tax return and audited financial statement: stamped “RECEIVED” by the BIR or BIR authorized collecting agent for the immediately preceding year.

Submitted by:

Name of Supplier/Distributor/Manufacturer

Signature of Authorized Representative

Date : _____

Note: If Partnership or Joint Venture, each Partner or Member Firm of Joint Venture shall submit the above requirements

List of all Ongoing Government & Private Contracts including contracts awarded but not yet started

Business Name : _____

Business Address : _____

Name of Contract / Project Cost	a. Owner's Name b. Address c. Telephone Nos.	Nature of Work	Bidder's Role		a. Date Awarded b. Date Started c. Date of Completion	% of Accomplishment		Value of Outstanding Works / Undelivered Portion
			Description	%		Planned	Actual	
<i>Government</i>								
<i>Private</i>								

(Use additional sheets if necessary)

Submitted by : _____
(Print Name & Signature)

Designation : _____

Date : _____

Statement of all Completed Government & Private Contracts

Business Name : _____

Business Address : _____

Name of Contract / Project Cost	a.Owner's Name b.Address c.Telephone Nos.	Nature of Work	Bidder's Role		a. Amount of Award b. Amount of Completion c. Date of Completion	a. Date Awarded b. Contract Effectivity c. Date of Completed d. Contract Performance certified by End User
			Description	%		
<i>Government</i>						
<i>Private</i>						

Note: The Bidder shall be able to support this statement with:

Duly signed Contracts, PO's, Agreements, Memoranda of Agreement, Notices of Award, Job Orders or Notices to Proceed with corresponding Certificates of Completion, Certificates of Acceptance, duly signed Delivery Receipts or duly signed Inspection and Acceptance Report

Submitted by : _____
(Print Name & Signature)

Designation : _____

Date : _____

SEALING AND MARKING OF BIDS (TWO-ENVELOPE SYSTEM)

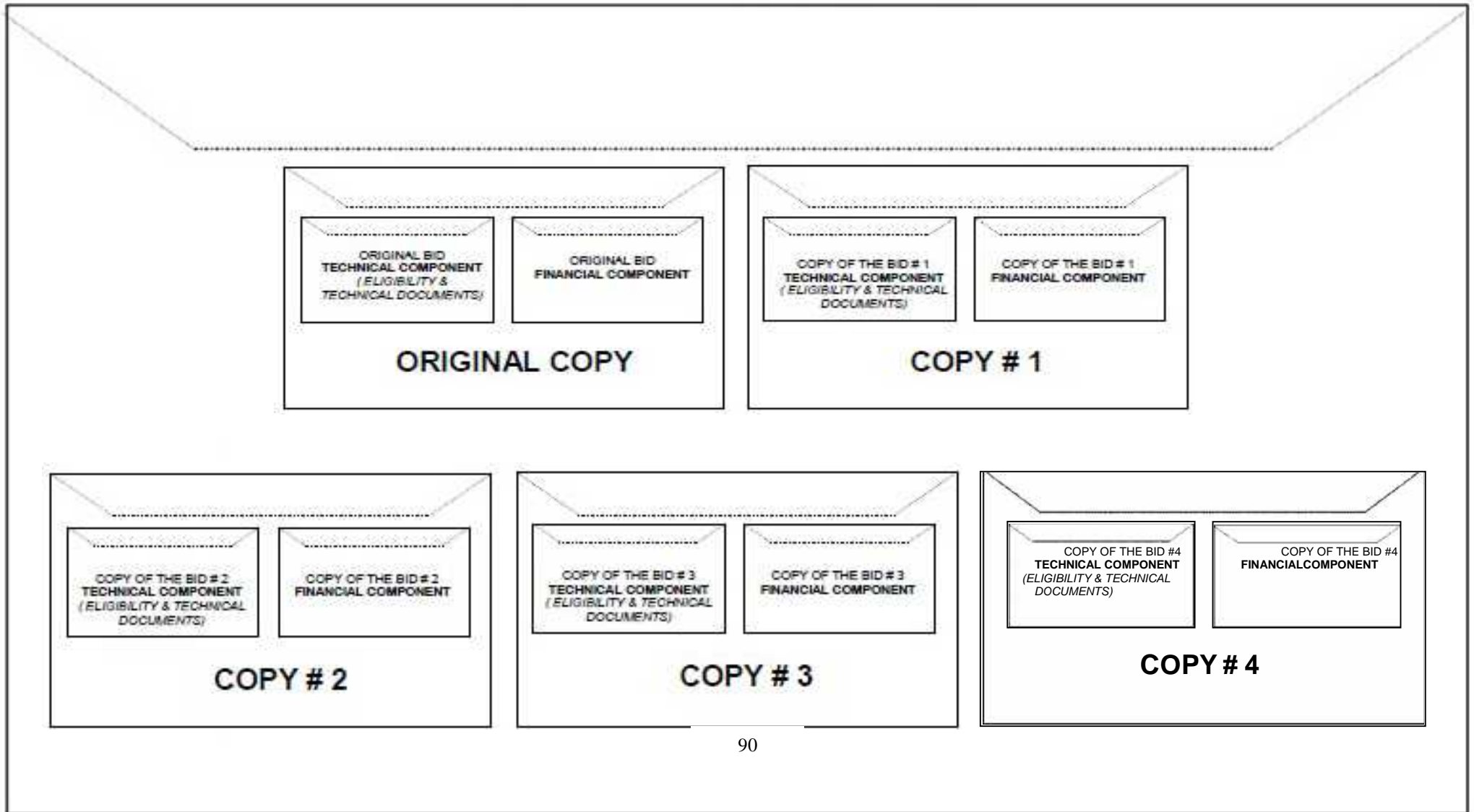

The outer envelope as described in ITB clause 20.2 shall be marked as:

ORIGINAL / COPY NO. _____

[BIDDER'S COMPANY NAME]
[COMPANY'S OFFICE ADDRESS]
[NAME OF PROJECT/BIDDING]

THE CHAIRPERSON
BIDS AND AWARDS COMMITTEE
ROAD BOARD
2ND FLOOR AVE MARIA BUILDING, 1517
QUEZON AVENUE COR. EXAMINER ST., QUEZON CITY

DO NOT OPEN BEFORE [TIME AND DATE OF BID OPENING]

The envelopes containing the original and the copies shall then be enclosed in one single envelope and shall be marked as:

[BIDDER'S COMPANY NAME]
[COMPANY'S OFFICE ADDRESS]
[NAME OF PROJECT/BIDDING]

THE CHAIRPERSON
BIDS AND AWARDS COMMITTEE
ROAD BOARD
2ND FLOOR AVE MARIA BUILDING, 1517
QUEZON AVENUE COR. EXAMINER ST., QUEZON CITY

DO NOT OPEN BEFORE [TIME AND DATE OF BID OPENING]

